

**Mayer-Vietoris property for relative symplectic
cohomology**

by

Umut Varolgunes

Submitted to the Department of Mathematics
in partial fulfillment of the requirements for the degree of

Doctor of Philosophy

at the

MASSACHUSETTS INSTITUTE OF TECHNOLOGY

June 2018

© Massachusetts Institute of Technology 2018. All rights reserved.

Author
Department of Mathematics
April 6, 2018

Certified by
Paul Seidel
Professor
Thesis Supervisor

Accepted by
Davesh Maulik
Chairman, Department Committee on Graduate Theses

Mayer-Vietoris property for relative symplectic cohomology

by

Umut Varolgunes

Submitted to the Department of Mathematics
on April 6, 2018, in partial fulfillment of the
requirements for the degree of
Doctor of Philosophy

Abstract

In this thesis, I construct and investigate the properties of a Floer theoretic invariant called relative symplectic cohomology. The construction is based on Hamiltonian Floer theory. It assigns a module over the Novikov ring to compact subsets of closed symplectic manifolds. I show the existence of restriction maps, and prove that they satisfy the Hamiltonian isotopy invariance property, discuss a Kunneth formula, and do some example computations. Relative symplectic cohomology is then used to establish a general criterion for displaceability of subsets. Finally, moving on to the main contribution of my thesis, I identify a natural geometric situation in which relative symplectic cohomology of two subsets satisfy the Mayer-Vietoris property. This is tailored to work under certain integrability assumptions, the weakest of which introduces a new geometric object called a barrier - roughly, a one parameter family of rank 2 coisotropic submanifolds. The proof uses a deformation argument in which the topological energy zero (i.e. constant) Floer solutions are the main actors.

Thesis Supervisor: Paul Seidel

Title: Professor

Acknowledgments

First and foremost, I thank my advisor, Paul Seidel, for suggesting the problem that lead to this thesis, and also for many enlightening discussions. More generally, he has made my PhD experience a very smooth one by always providing the necessary tools and resources precisely when I needed them (mathematically and logistically). Many many thanks. I am also grateful to my undergraduate advisor Richard Melrose for providing me with the enthusiasm to pursue mathematics as a professional career.

Throughout my PhD I have benefited from discussions with friends: Yusuf Baris Kartal, Roger Casals, Dmitry Tonkonog, Peter Smillie, Dani Alvarez-Gavela, Kyler Siegel, Zack Sylvan, Kevin Sackel and others. Special thanks go to Francesco Lin, for putting me on the right track on multiple occasions.

I learned a lot from Emmy Murphy, Larry Guth, Tom Mrowka, Yanki Lekili, and Mohammed Abouzaid. I am very grateful to all of them. Mohammed Abouzaid also provided me with the opportunity of spending time at Columbia University during my 4th year, which was extremely helpful. Special thanks for that to him.

I have had fruitful discussions with Yoel Groman, Mark McLean, Alex Oancea, John Pardon during the preparation of this thesis. Mark McLean also read through a draft and sent me his comments, which made the exposition better.

My family and my girlfriend provided constant love and support, and continue to do so. I thank them every day. Last but not least, I thank all my friends: in Turkey, in Cambridge, in New York... (I also thank Jason Palmer).

Contents

1	Introduction	11
1.1	Motivation from mirror symmetry	11
1.2	Relative symplectic homology as a local invariant	13
1.2.1	Outline of the construction	14
1.2.2	An example: subsets of the two sphere	17
1.2.3	Comparison with literature	19
1.3	Properties of relative symplectic cohomology	21
1.3.1	Displaceability	22
1.4	Mayer-Vietoris property	23
1.4.1	Non-intersecting boundaries	25
1.4.2	Barriers	26
1.4.3	Involutive systems	28
1.5	Outline of the thesis	29
2	Algebra preparations	31
2.1	Commutative algebra over the Novikov ring	31
2.1.1	Acyclicity of chain complexes over $\Lambda_{\geq 0}$	32
2.2	Homotopical constructions	34
2.2.1	Cubes	34
2.2.2	Maps between n -cubes	35

2.2.3	n -cubes with positive signs	38
2.2.4	Cones of n -cubes	39
2.2.5	Composing n -cubes	41
2.2.6	Rays	43
2.2.7	Cones and telescopes of n -rays	44
2.3	1-rays and quasi-isomorphisms	45
2.4	Completion of modules and chain complexes over the Novikov ring . .	47
2.5	Acyclic cubes and an exact sequence	49
3	Definition and Basic properties	53
3.1	Conventions	53
3.2	Hamiltonian Floer theory	55
3.2.1	Monotone families	59
3.2.2	Contractibility	60
3.3	Construction of the invariant	64
3.3.1	Cofinality	64
3.3.2	Definition and basic properties	65
3.3.3	Computing $SH_M(M)$ and $SH_M(\emptyset)$	67
3.4	Multiple subsets	68
4	Properties of relative symplectic cohomology: proofs	71
4.1	Hamiltonian isotopy invariance of restriction maps	72
4.2	Displaceability property	73
4.2.1	Changing the supports of Hamiltonians in the time interval . .	73
4.2.2	Twisting relative symplectic cohomology by Hamiltonians . . .	75
4.2.3	Finishing the proof: dying generators	76
4.3	Kunneth formula	78

5	Mayer Vietoris property	81
5.1	An algebraic result	81
5.2	Zero energy solutions	83
5.3	Boundary accelerators	86
5.4	Non-intersecting boundaries	92
5.5	Barriers	95
5.6	Non-degeneracy	98
5.7	The proof of the main theorem	99
5.7.1	Neighborhoods of intersections of the boundary	100
5.7.2	Tangentialization	101
5.8	Instances of barriers	105
5.9	Involutive systems	107
5.9.1	A slight generalization of the main theorem	107
5.9.2	Descent for symplectic manifolds with involutive structure	109
A	Cubical diagrams	111
B	Descent for multiple subsets	113

Chapter 1

Introduction

A fundamental property of homological invariants in topology and algebraic geometry is that they satisfy local-to-global properties. Probably the most basic example of this is the Mayer-Vietoris exact sequence satisfied by the singular homology of topological spaces. My thesis explores such properties in the context of Floer theoretic invariants in symplectic geometry.

1.1 Motivation from mirror symmetry

The main motivation for beginning this study was mirror symmetry for symplectic manifolds admitting a possibly singular Lagrangian torus fibration (LTF). This line of thought began with the SYZ conjecture for Calabi-Yau manifolds [36], which led Leung to give a construction of a mirror CY partner starting with a smooth special LTF on the symplectic manifold [24]. Kontsevich and Soibelman analyzed the case of abelian varieties in detail, and introduced the idea of using non-archimedean geometry in constructions [18]. Using Fukaya's Family Floer cohomology [13], a more general mirror construction was given by Abouzaid, for any symplectic manifold with a smooth LTF [1].

Both SYZ and Family Floer constructions are local in nature, meaning that the mirror is constructed by gluing together local models associated to domains of action-angle coordinate systems. A very important piece in the puzzle has been to understand how to incorporate quantum corrections in the construction. In another paper analyzing $K3$ surfaces, Kontsevich and Soibelman suggested that they should deform the gluing maps at higher orders by means of a wall-crossing formula [19]. This relied on a detailed local analysis of the so called focus-focus singularity. Even though it was a fascinating construction, it was slightly disappointing from a symplectic geometer's viewpoint, because the gluing procedure seemed tailored to a more algebro-geometric set-up (and it was generalized in that set-up to great success by the Gross-Siebert program [15]). The end result itself suggested that there might be a simpler, yet possibly less explicit construction, leading to mirrors of $K3$ -surfaces taking only their symplectic geometry into account.

The primary precursor to the main results of this thesis is [33]. Seidel considers non-trivial examples where Floer theoretic invariants of symplectic manifolds with pair-of-pants decompositions [26]¹ are related to standard invariants of some mirror space through homological mirror symmetry statements. By construction these mirror spaces also admit a corresponding decomposition into standard pieces (similar to the SYZ picture above). What Seidel observes is that the invariants of the mirror are local in the sense that they can be constructed by gluing invariants of the pieces from the decomposition. He then suggests that such locality might be true for Floer theoretic invariants when the manifold admits a LTF and locality is understood as "local in the base". This idea was used to great effect for Riemann surfaces by Lee [22], using the results of [2].

In this thesis, we first make the question of locality rigorous by defining the local Floer theoretic invariants, and interpreting locality as a Mayer-Vietoris sequence. We

¹these are morally lifted from decompositions of the base of an LTF with singularities, see [26]

then explain the mechanism underlying the observations coming from mirror symmetry. The context of our statements are considerably more general than integrable systems, but a shadow of integrability still remains in the picture.

1.2 Relative symplectic homology as a local invariant

In [33], Seidel constructs the local invariant of a standard neighborhood of a smooth fiber of the LTF using a "wrapping" procedure near the boundary (standard in symplectic cohomology from the beginning, see the references in the beginning of Subsection 1.2.3), and then adding certain formal sums to the resulting Floer chain complex. Relative symplectic homology extends his construction to general compact subsets of closed symplectic manifolds in the context of closed string theory. The theory could be extended to open strings and also to certain open manifolds, but we do not explore these in this thesis to stay focused on the new ideas we put forth.

Denote the Novikov ring, and field over the rational numbers by $\Lambda_{\geq 0}$, and Λ , respectively. Let M be a closed symplectic manifold. Relative symplectic cohomology $SH_M(K)$ is a \mathbb{Z}_2 -graded $\Lambda_{\geq 0}$ -module assigned to each compact $K \subset M$. For any $K' \subset K$, there are canonical module maps, called restriction maps:

$$SH_M(K) \rightarrow SH_M(K'). \tag{1.2.0.1}$$

In the next subsection we give an outline of the construction, but the theory is fully developed in Chapters 2 and 3.

1.2.1 Outline of the construction

Let $h, h' \in C^\infty(M \times S^1, \mathbb{R})$. A monotone homotopy from h to h' is a smooth map $H : M \times S^1 \times [0, 1]_s \rightarrow \mathbb{R}$ with $H|_{s=0} = h$ and $H|_{s=1} = h'$ which satisfies $\frac{\partial H}{\partial s} \geq 0$. If $h' \geq h$, then the space of monotone homotopies is contractible, and otherwise it is empty. One needs to develop a framework to realize the full potential of such a statement in Floer theory (Subsection 3.2.2), but for this section we simply call it contractibility.

We take a sequence of one-periodic Hamiltonians $H_1 < H_2 < \dots$ on M with non-degenerate one-periodic orbits, which are cofinal among functions that are strictly negative on K (this idea is due to Floer-Hofer [12], also see Subsection 3.3.1 for further discussion). We also choose monotone homotopies $\{H_s\}_{s \in [i, i+1]}$, for all $i \in \mathbb{N}$. Using Hamiltonian Floer theory (see Section 3.2) we can associate to this data, which is called the **acceleration data**, a linear diagram of free $\Lambda_{\geq 0}$ -chain complexes:

$$CF(H_1) \rightarrow CF(H_2) \rightarrow CF(H_3) \rightarrow \dots \quad (1.2.1.1)$$

Before moving further, we now describe our version of "adding formal sums". For $r \geq 0$, by $\Lambda_{\geq r}$ we denote the ideal of $\Lambda_{\geq 0}$ consisting of the elements with valuation at least r (see Section 2.1 for more details). Let A be a $\Lambda_{\geq 0}$ -module. The **completion** of A is defined as:

$$\widehat{A} := \varprojlim_{r \geq 0} A \otimes_{\Lambda_{\geq 0}} \Lambda_{\geq 0} / \Lambda_{\geq r}. \quad (1.2.1.2)$$

More concretely, one can think of \widehat{A} as equivalence classes of Cauchy sequences in A . This viewpoint is better for computations, and is explained in detail in Section 2.4.

We then define relative symplectic cohomology as the homology of the completion

of the direct limit:

$$SC_M(K) := \varprojlim_{r \geq 0} \varinjlim_i CF(H_i) \otimes_{\Lambda_{\geq 0}} \Lambda_{\geq 0} / \Lambda_{\geq r} \quad (1.2.1.3)$$

$$SH_M(K) := H(SC_M(K)). \quad (1.2.1.4)$$

Here we unfolded the completion part, and also did not put any paranthesis, to highlight that each single truncation (i.e. $\cdot \otimes_{\Lambda_{\geq 0}} \Lambda_{\geq 0} / \Lambda_{\geq r}$) commutes with the direct limit, by virtue of being a tensor product. Using contractibility, we get that $SH_M(K)$ is well defined. See Subsection 3.3.2 for the details.

Remark 1.2.1. *In general, it is better to take a homotopy direct limit (i.e. the telescope construction as in [3]) instead of the usual direct limit. This gives the same invariant (Lemma 2.4.4), but is a lot more functorial from the view point of Floer theory. The construction of restriction maps in Subsection 3.3.2 illustrates this point. The homotopy colimit is also free as a $\Lambda_{\geq 0}$ -module, and hence its completion in terms of Cauchy sequences is easier to describe.*

Remark 1.2.2. *The $\mathbb{Z}/2$ -grading is given by the Lefschetz fixed point index, but we will ignore it in the rest of this Chapter.*

Remark 1.2.3. *The reader might be wondering why we needed to complete our chain complex, since $H(\varinjlim_i CF(H_i, M))$ can be shown to be well-defined as an invariant of K already. There are two reasons for this. One is opportunistic, as the homology of the completed complex captures more chain level information. Let us illustrate this point. An important invariant of a $\Lambda_{\geq 0}$ -module is obtained by killing its torsion, i.e. tensoring it with its fraction field Λ (flat over $\Lambda_{\geq 0}$). We claim that $H(\varinjlim_i CF(H_i, M)) \otimes \Lambda$ does not depend on K at all.*

First of all, after tensoring with Λ , each of the continuation maps

$$CF(H_i, M) \rightarrow CF(H_{i+1}, M) \tag{1.2.1.5}$$

become quasi-isomorphisms. This is because one can construct a continuation map over Λ in the other direction, which is a two sided homotopy inverse. By the PSS isomorphism as in Pardon [29], Section 10, we also have canonical quasi-isomorphisms

$$CF(H_i, M) \otimes_{\Lambda_{\geq 0}} \Lambda \rightarrow C^*(M, \mathbb{Z}) \otimes \Lambda. \tag{1.2.1.6}$$

These maps are compatible with the continuation maps, and using that flat tensor products commute with homology and direct limit, we obtain:

$$H(\varinjlim_i CF(H_i, M)) \otimes_{\Lambda_{\geq 0}} \Lambda = H^*(M, \Lambda), \tag{1.2.1.7}$$

as Λ -vector spaces. On the other hand $SH_M(K) \otimes_{\Lambda_{\geq 0}} \Lambda$ can be shown to depend on K in many examples (see Example 1.2.2 for the $M = S^2$ case).

The second reason is heuristic: we want the invariant to be as local as possible. The simplest way to put what completion achieves in this direction is as follows. Let T be the Novikov parameter. Assume that there is a closed element γ in $CF(H_i)$ whose image (under the maps in the linear diagram) lies in $T^{r_j}CF(H_j)$, for some $r_j \rightarrow \infty$, as $j \rightarrow \infty$. Then, the image of $[\gamma]$ under the canonical map $HF(H_i) \rightarrow SH_M(K)$ is zero. This does not imply a statement of the sort "the generators that lie far away from K do not contribute to the final module", but it is in that direction. The vanishing of the invariant for the empty set (Subsection 3.3.3) and the proof of the displaceability property (Section 4.2) well illustrates this point.

1.2.2 An example: subsets of the two sphere

Let S be a two-sphere endowed with an area form. Let $K \subset S$ be a subset obtained by removing a finite number of open disks from S . Then,

$$SH_S(K) \otimes_{\Lambda_{\geq 0}} \Lambda = \begin{cases} 0, & \text{if } K \text{ is displaceable} \\ \Lambda \oplus \Lambda, & \text{otherwise} \end{cases}. \quad (1.2.2.1)$$

It is elementary to see that displaceability is equivalent to area of one of the removed disks being more than a half of the area of S . Note that the Computation (1.2.2.1) actually follows from the general properties (global sections and displaceability as in Section 1.3, and the Mayer-Vietoris sequence as in Section 1.4), but let us informally present part of the computation when K is a closed disk to show the effect of completion more concretely. Note that by a relative Moser argument any smooth closed disk can be taken to any other one with the same area by a Hamiltonian isotopy of S^2 . Therefore, we start with a special one to simplify the notation.

Let S have area 1, and $m : S \rightarrow [0, 1]$ be the moment map. We can think of S as $\{x_1, x_2, x_3 \mid x_1^2 + x_2^2 + (x_3 - 1/2)^2 \leq 1/4\} \subset \mathbb{R}^3$ and m as the projection to the x_3 -axis. Let $\mathbb{D} = \{m(x) \leq \Delta\}$, so $area(\mathbb{D}) = \Delta$ and $area(S - \mathbb{D}) = 1 - \Delta$.

We construct a cofinal family by taking functions $h_n : [0, 1] \rightarrow \mathbb{R}$ satisfying

1. $h_n < h_{n+1}$
2. $h_n < 0$ on $[0, \Delta]$
3. h_n is linear with slope $c_n > 0$ on $[0, \Delta + \epsilon_n]$ and $[\Delta + 2\epsilon_n, 1]$ for some $\epsilon_n > 0$, with $c_n \rightarrow 0$ and $\epsilon_n \rightarrow 0$, as $n \rightarrow \infty$
4. h'_n is a concave function, and its maximum value is an irrational number
5. $h_n(0) \rightarrow 0$ and $h_n(1) \rightarrow \infty$, as $n \rightarrow \infty$,

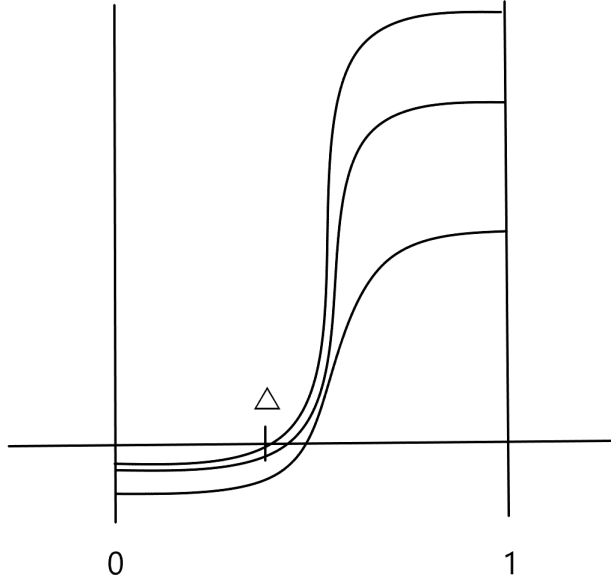

Figure 1-1: The shape of the graphs of the functions we constructed

composing them with m , and using the standard techniques for dealing with S^1 -degeneracies [5]. Note that $h_n \circ m$ has exactly two critical points (a minimum and a maximum), and its non-constant one-periodic orbits are contained at the level sets of h_n with $h'_n \in \mathbb{Z}$.

It is a non-trivial computation that the resulting complex $SC_S(\mathbb{D})$ is quasi-isomorphic to $C \oplus C$, where C is the following chain complex:

- $C = \widehat{\bigoplus}_{i \geq 0} \Lambda_{\geq 0} \cdot \gamma_i \oplus \Lambda_{\geq 0} \cdot \beta_{i+1}$, where $\widehat{\bigoplus}$ is the completed direct sum, as in Section 2.4.
- $d\gamma_i = 0$, $d\beta_{i+1} = T^\Delta \gamma_i + T^{1-\Delta} \gamma_{i+1}$.

Remark 1.2.4. *Note that because the minimal Chern number is 2, we actually have a \mathbb{Z}_4 -grading here (and the differential increases indices in our conventions). The above splitting is then given by the splitting of the generators with grading $3, 0$ in one*

group, and the ones with 1, 2 in the other. See Remark 3.1.1 for more on our grading conventions.

Without the $T^{1-\Delta}$ term in the differential, the complex C should be familiar to the reader who has seen the computation of the symplectic cohomology of a 2-disk [27], which would be K in our case. The $T^{1-\Delta}$ term comes from solutions of the Floer equation that intersect the maximum (exploring the complement of K).

Note that $H(C) \otimes_{\Lambda_{\geq 0}} \Lambda = H(C \otimes_{\Lambda_{\geq 0}} \Lambda)$ is generated by $[\gamma_0]$, since

$$\gamma_{n+1} - \gamma_0 = d(T^{-\Delta}(\beta_1 - T^{1-2\Delta}\beta_2 + T^{2(1-2\Delta)}\beta_3 - \dots \pm T^{n(1-2\Delta)}\beta_{n+1})). \quad (1.2.2.2)$$

Moreover, we have that γ_0 has a primitive if and only if the sum $\sum_{k=0}^n T^{k(1-2\Delta)}\beta_{k+1}$ converges to an element of C as $n \rightarrow \infty$, which is equivalent to $1 - 2\Delta > 0$. This gives the desired result.

1.2.3 Comparison with literature

Now we discuss the relationship between $SH_M(K)$ and similar invariants from the literature. In their seminal paper, Floer and Hofer constructed an invariant that they called symplectic homology for (bounded!) open subsets of $(\mathbb{R}^{2n}, \omega_{st})$ [12]. This was generalized to aspherical manifolds with contact (or no) boundary in [6]. In a more explicit construction, Viterbo defined an intrinsic invariant in the contact boundary case that only depends on the completion of the domain [39]. More recently, Cieliebak-Oancea generalized Viterbo's construction to Liouville cobordisms [7]. Among the many results they proved is a Mayer-Vietoris sequence that we briefly compare with ours in Remark 1.4.4.

Cieliebak et al. also commented that their constructions could be generalized to non-aspherical manifolds by the use of Novikov parameters in Section 5 of [6]. It appears that the first time in the literature this was picked up again was in Groman

[14]. Groman’s definition of reduced symplectic cohomology is very similar to ours, but it is not the same. His chain level invariant as a Λ chain complex is the same as ours, and he uses action filtrations to replace our defining the invariant over $\Lambda_{\geq 0}$. He also uses the language of topological vector spaces, rather than commutative algebra. Yet, the real difference seems to be that he takes the closure of the image of the differential on this complex before taking homology. Both variants seem to be useful, and we leave the further comparison to the interested reader.

Another relevant paper is the one of Venkatesh, where she also utilizes the completion procedure to recover some quantitative information from a chain complex over Λ (see her paper for a more complicated example in the spirit of our sphere example) [38]. Her invariant is an intrinsic invariant defined for monotone symplectic manifolds with contact boundary (monotonicity could be removed for purposes of just defining the invariant). However, unlike Viterbo’s symplectic homology, it does not factor through the completion of the domain as it keeps track of topological energies of Floer solutions. The relevant comparison question for us is the following:

Question. Let $K \subset M$ be a compact domain with convex boundary. Let us denote the intrinsic invariant of Venkatesh by $\widehat{SH}(K)$. What is the relationship between $\widehat{SH}(K)$ and $SH_M(K) \otimes \Lambda$?

Note that a similar question was answered for Floer-Hofer and Viterbo versions of symplectic cohomology in [27], proving that those invariants are the same. Our situation is considerably more complicated. There are two potential sources of difference, the first one is the extra generators in $SC_M(K)$, and the second one is the pseudo-holomorphic curves in M that are not contained in K . While we understand under what conditions the latter issue does not occur, the former seems slightly mysterious as of now.

Last but not least, a recent preprint of McLean [25] uses an invariant in the same vein to prove that birational equivalences of projective CY varieties preserve quantum

cohomology (roughly speaking). During the course of his involved proof, he identifies a situation (most important assumption is "index boundedness") in which extra generators (as in the previous paragraph) do not contribute. The actual statement that he proves is too complicated to state here. We make another reference to Mclean's work in Remark 4.3.1, in which we explain a little bit more of his setup.

1.3 Properties of relative symplectic cohomology

The following properties should convince the reader that relative symplectic cohomology is an important invariant that deserves to be studied independently of mirror symmetry considerations. The proofs are given in the main body of the text (see the Outline Section for where the proofs are located).

Theorem 1.3.1. *Relative symplectic cohomology satisfies the following properties.*

- *(coordinate independence)* Let $\phi : M \rightarrow M$ be a symplectomorphism, then there exists a canonical relabeling isomorphism $SH_M(K) \rightarrow SH_M(\phi(K))$.
- *(global sections)* $SH_M(M) = H(M, \mathbb{Z}) \otimes \Lambda_{>0}$ as $\Lambda_{\geq 0}$ -modules, where $\Lambda_{>0}$ is the maximal ideal of $\Lambda_{\geq 0}$.
- *(empty set)* $SH_M(\emptyset) = 0$.
- *(restriction maps)* For any $K' \subset K$, there are canonical module maps:

$$SH_M(K) \rightarrow SH_M(K'). \tag{1.3.0.1}$$

Moreover, if $K'' \subset K' \subset K$, the map $SH_M(K) \rightarrow SH_M(K'')$ is equal to the composition $SH_M(K) \rightarrow SH_M(K') \rightarrow SH_M(K'')$.

- *(Hamiltonian isotopy invariance of restriction maps)* Let $\phi_t : M \rightarrow M$, $t \in [0, 1]$, be a Hamiltonian isotopy such that $\phi_t(K) \subset K'$ for all t . We have a

commutative diagram

$$\begin{array}{ccc}
 SH_M(K') & \longrightarrow & SH_M(\phi_1(K)) \\
 & \searrow & \downarrow \phi_1^{-1} \\
 & & SH_M(K).
 \end{array} \tag{1.3.0.2}$$

- (displaceability condition) Let $K \subset M$ be displaceable by a Hamiltonian diffeomorphism, then $SH_M(K) \otimes_{\Lambda_{\geq 0}} \Lambda = 0$.
- (Kunneth formula) Let $K \subset M$ and $K' \subset M'$, we have an explicitly defined module map $SH_M(K) \otimes_{\Lambda_{\geq 0}} SH_{M'}(K') \rightarrow SH_{M \times M'}(K \times K')$. See Section 4.3 for a more precise statement.

1.3.1 Displaceability

The displaceability property is the most serious among these properties. This property was proven for Liouville domains by Kang [16] for Viterbo's symplectic cohomology, and aspherical manifolds by Groman [14] for his reduced symplectic cohomology. Their methods are pretty different: Groman's relies on spectral invariants, whereas Kang's proof is based on a geometric argument that seems to have originated in the study of leafwise intersections of coisotropics via Rabinowitz Floer homology [4]. Mclean also proves a very related result (see Remark 4.3.1), which is tailored to his setup.

Our proof is based on Kang's, but requires a significant extra step, which involves obtaining lower bounds for topological energies of certain continuation map equations (Proposition 4.2.7). This bound is obtained by understanding the locations of the images of continuation map solutions after a certain adiabatic limiting procedure.

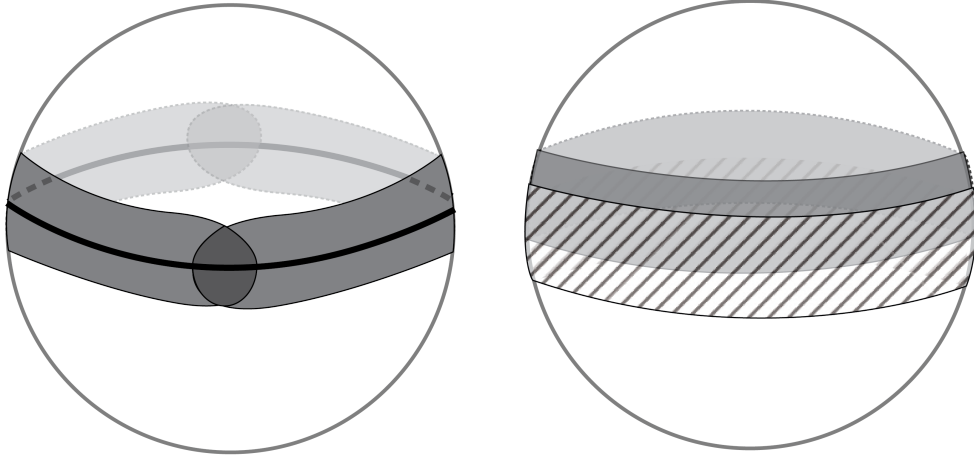

Figure 1-2: On the left there are two subsets that cannot satisfy Mayer-Vietoris, and on the right are two that do. The thick circle on the left divides the sphere into equal areas.

1.4 Mayer-Vietoris property

As we discussed earlier, the main task of this thesis is to analyze the question: does $SH_M(\cdot)$ satisfy the Mayer-Vietoris property, i.e. for K_1, K_2 compact subsets of M , is there an exact sequence

$$\begin{array}{ccc}
 SH_M(K_1 \cup K_2) & \longrightarrow & SH_M(K_1) \oplus SH_M(K_2), \\
 \uparrow [1] & \swarrow & \\
 SH_M(K_1 \cap K_2) & &
 \end{array}
 \tag{1.4.0.1}$$

where the degree preserving maps are the restriction maps (up to sign)?

Mayer-Vietoris property does not hold in general. In Figure 1-2, we see examples of pairs of subsets inside the two sphere that does and cannot satisfy Mayer-Vietoris property (see Example 1.2.2 for a discussion).

Remark 1.4.1. *Using the displaceability and global sections properties, and the fact that any symplectic manifold can be covered by displaceable subsets, we get a concep-*

tual counterexample to any possible notion of locality in the manifold.

One piece of good news is that we can measure the failure of the Mayer-Vietoris property to hold. Slightly generalizing the situation, let K_1, \dots, K_n be compact subsets of M . Using Floer theory, we can construct a chain complex $SC_M(K_1, \dots, K_n)$: an explicit deformation of the chain complex $\bigoplus_{I \subset [n]} SC_M(\bigcap_{i \in I} K_i)$, w.r.t the $|I|$ -filtration (i.e. the full differential is lower triangular, and the diagonal entries are the differentials from before). Here I being the empty set means taking the union of K_i 's.

More specifically, in this deformation the part of the differential that increases $|I|$ -filtration by 1 are given by restriction maps, the ones that increase by 2 are chain homotopies between compositions of restriction maps in different directions and so on. The data of $SC_M(K_1, \dots, K_n)$ should be visualized in the following way. The modules underlying the summands of $\bigoplus_{I \subset [n]} SC_M(\bigcap_{i \in I} K_i)$ are placed on the vertices of an n -dimensional cube (with an ordering of its coordinates), and the differential is the direct sum of maps indexed by the faces (including the vertices) of the cube, going between the initial and terminal vertices of that face. Such diagrams will be called cubical diagrams, or n -cubes (see Subsection 2.2.1).

Remark 1.4.2. *Cubical diagrams were used to great effect by Kronheimer-Mrowka in their celebrated paper [20] to obtain the necessary spectral sequences. We warn the reader that their signs work out slightly differently than ours.*

The homology of $SC_M(K_1, \dots, K_n)$ only depends on K_1, K_2, \dots, K_n (Section 3.4), therefore the following definition makes sense.

Definition 1. K_1, K_2, \dots, K_n satisfies **descent**, if $SC_M(K_1, \dots, K_n)$ is acyclic.

Satisfying descent implies the existence of a convergent spectral sequence:

$$\bigoplus_{0 \neq I \subset [n]} SH_M \left(\bigcap_{i \in I} K_i \right) \Rightarrow SH_M \left(\bigcup_{i=1}^n K_i \right), \quad (1.4.0.2)$$

which produces a Mayer-Vietoris sequence for $n = 2$ as in Equation 1.4.0.1 above.

Let us now discuss some cases in which Mayer-Vietoris/descent properties are satisfied.

1.4.1 Non-intersecting boundaries

We start with a relatively simple situation. We note that the following theorem is not trivial, and the reader might find it useful to understand the ideas involved in its proof first. Hence, we gave its rigorous proof separately in Section 5.4.

Theorem 1.4.3. *Let $K_1, \dots, K_n \subset M$ be compact domains². Assume that the boundaries of K_i are pairwise disjoint. Then, descent is satisfied.*

We give a rough sketch of the proof here. We can always choose the Hamiltonians defining relative symplectic cohomology of a domain in such a way that the interesting dynamics happen near the boundary (for details Subsection 5.3). For ease of explanation, let $n = 2$. Because the boundaries are disjoint, a compatible choice of such Hamiltonians results in non-constant orbits for K_1 or K_2 occurring exactly once again for $K_1 \cap K_2$ or $K_1 \cup K_2$. Hence each non-constant generator in $SC_M(K_1, K_2)$ occurs exactly twice (say γ, γ'), so that $d\gamma = \gamma' + \text{higher order terms}$. The story is similar for constant orbits. Using the fact that truncating the positive energy terms in the differential of chain complex over $\Lambda_{\geq 0}$ cannot reduce the rank of homology groups (the acyclicity lemma for $\Lambda_{\geq 0}$ -modules, Lemma 2.1.3), we get the desired acyclicity.

Remark 1.4.4. *For $n = 2$, this produces a Mayer-Vietoris sequence as we have commented on before. A similar Mayer-Vietoris sequence for their version of symplectic homology, when K_1 and K_2 are Liouville cobordisms inside a Liouville domain M satisfying a number of conditions (one of them being that their union and intersection is also a Liouville cobordism) was established by Cieliebak-Oancea in Theorem 7.17 of*

²a codimension zero submanifold with boundary.

[7]. In the case that it applies, their statement is different (and in our opinion more useful) than ours. This is because among the four cobordisms in question two of them do not have the boundary of M as their positive boundary. Their invariant for those two do not depend on the cobordism that fills between their positive boundary and the boundary of M , whereas ours a priori depends on all of M . Analyzing the precise relationship between these two Mayer-Vietoris sequences involve questions that are similar to the one raised in Subsection 1.2.3, and is subject of future research.

1.4.2 Barriers

When the boundaries intersect the situation is more complicated, and we need to make serious geometric assumptions.

The following observation is crucial in our argument.

Lemma 1.4.5. *Let $X \subset M$ be a hypersurface. Take another hypersurface $Z \subset H$. Then, the characteristic line field of X is tangent to Z if and only if Z is coisotropic (rank 2).*

Therefore, we make the definition:

Definition 2. *Let Z^{2n-2} be a closed manifold. We define a **barrier** to be an embedding $Z \times [-\epsilon, \epsilon] \rightarrow M^{2n}$, for some $\epsilon > 0$, where $Z \times \{a\} \rightarrow M$ is a coisotropic for all $a \in [-\epsilon, \epsilon]$. We call the image of $Z \times \{0\}$ the **center** of the barrier, and the vector field obtained by pushing forward $\partial_\epsilon \in \Gamma(Z \times \{0\}, T(Z \times (-\epsilon, \epsilon))|_{Z \times \{0\}})$ to M the **direction** of the barrier.*

The proof of the following theorem uses the same ideas as in the proof of Theorem 1.4.3, but it is quite a bit more technical.

Theorem 1.4.6. *(Mayer-Vietoris sequence) Let $K_1, K_2 \subset M$ be compact domains. Assume that ∂K_1 and ∂K_2 intersect along a rank 2 coisotropic which is the center of*

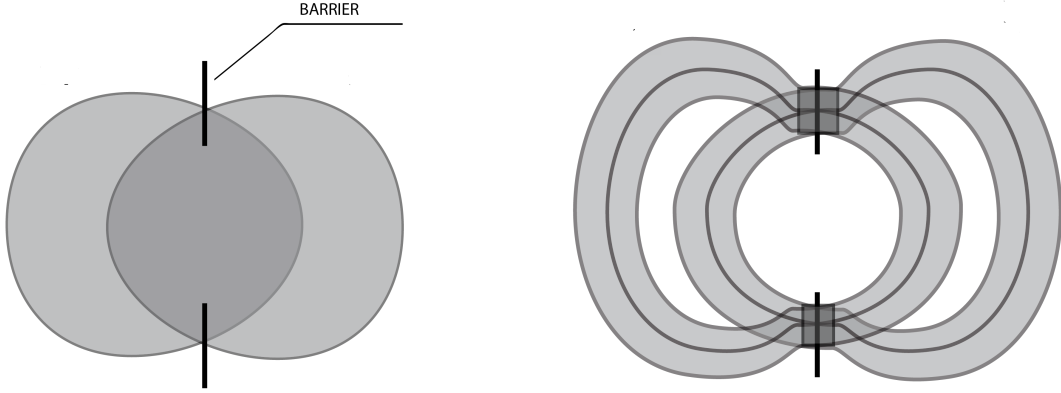

Figure 1-3: We see a cartoon of K_1, K_2 , and the location of the barrier on the left. The picture on the right represents the union of the neighborhoods of the boundaries of two tangentially intersecting domains that envelop K_i 's with a thin margin.

a barrier whose direction points out of $K_1 \cup K_2$. Then, K_1 and K_2 satisfy descent. Therefore, we have an exact sequence:

$$\begin{array}{ccc}
 SH_M(K_1 \cup K_2) & \longrightarrow & SH_M(K_1) \oplus SH_M(K_2), & (1.4.2.1) \\
 \uparrow [1] & & \swarrow & \\
 SH_M(K_1 \cap K_2) & & &
 \end{array}$$

where the degree preserving maps are the restriction maps (up to signs).

We made the assumption that $K_1, K_2 \subset M$ are domains purely for the sake of keeping the statement simple. For the actual statement see Theorem 5.7.1. Note that in dimension 2, the condition is equivalent to boundaries not intersecting, as a point in a surface can never be coisotropic (see Figure 1-2). In dimension 4, it implies that the intersection is a disjoint union of Lagrangian tori, but unfortunately being outward pointing is an extra condition in this case, see Corollary 5.8.4.

A challenge in the proof of this theorem is that the intersection and union of

two domains is not a domain in general. This potentially results in generators near the corners that are hard to deal with. We bypass this issue by approximating the domains by other domains where the intersections are tangential. Figure 1-3 gives a cartoon of our strategy.

1.4.3 Involutive systems

Coming closer to our starting point of integrable systems, we make the following definition.

Definition 3. *An **involutive map** is a smooth map $\pi : M \rightarrow B$ to a smooth manifold B , such that for any $f, g \in C^\infty(B)$, we have $\{f \circ \pi, g \circ \pi\} = 0$*

Remark 1.4.7. *The most studied examples of involutive maps are Lagrangian fibrations (in other words integrable systems). These correspond to the case where the image of π has half the dimension of M (which is the most it can be).*

Theorem 1.4.8. *Let X_1, \dots, X_n be closed subsets of B . Then $\pi^{-1}(X_1), \dots, \pi^{-1}(X_n)$ satisfy descent.*

Remark 1.4.9. *A fancy way of saying the same thing is that $SC_M(\pi^{-1}(\cdot))$ gives a homotopy sheaf over the Grothendieck topology of compact subsets on B*

The following corollary was first proven by Entov-Polterovich under the assumption that M is strongly semi-positive using a completely different set of tools [10]. We provide its simple proof in full generality (assuming Theorem 1.4.8) here.

Corollary 1.4.10. *Any involutive map admits at least one fiber that is not displaceable by Hamiltonian isotopy.*

Proof. Let $\bigcup C_i$ be any finite cover of the image of M inside B by compact subsets. Theorem 1.4.8, and the global sections property shows that $SH_M(\pi^{-1}(\bigcap_J C_i)) \otimes \Lambda \neq$

0, for some non-empty $J \subset [n]$, by a spectral sequence argument. Hence, by the displaceability property, C_i is not displaceable for some i . Now assuming that each fiber is displaceable easily leads to a contradiction. \square

Remark 1.4.11. *Even though the tools are different, the logic of our proof is similar to [10] as the experts will notice. We also refer the reader to [10] for a more detailed exposition of the corollary above including many interesting examples.*

1.5 Outline of the thesis

In Chapter 2, we collect some algebraic facts together. In Section 1, we give a proof of the acyclicity lemma for $\Lambda_{\geq 0}$ -modules using commutative algebra methods. In Section 2, we switch gears and discuss the homotopical algebra of cubical diagrams. In the sequel Section 3, we discuss colimits and homotopy colimits of linear diagrams of chain complexes. In Section 4, we introduce the notion of completion for modules over the Novikov ring, discuss its interaction with (homotopy) colimits, show that completeness preserves acyclicity under certain assumptions, and give another proof of the acyclicity lemma. Section 5 puts everything together.

In Chapter 3, in the first three Sections, we define relative symplectic cohomology, construct restriction maps, and show these are well defined. $SH_M(M)$ and $SH_M(\emptyset)$ are computed in the third section. In the last section, we introduce relative symplectic cohomology of multiple compact subsets.

In Chapter 4, we finish the proofs of the Hamiltonian isotopy invariance of restriction maps, displaceability, and Kunneth properties. In Section 2, we introduce Hamiltonian twisted relative symplectic cohomology, which might be of independent interest.

Chapter 5 is where we discuss the Mayer-Vietoris/descent properties. We focus on the homology level statement for two subsets (i.e. the Mayer-Vietoris sequence) until

the last section for better readability. Section 1 is one long lemma that puts together the results we proved in the algebra section so that we can state the precise result we will prove using Floer theory - and from there algebra gives us the Mayer-Vietoris sequence. In Section 2, we further reduce the problem to showing the existence of a sequence of (pairs of) Hamiltonians that can be used as acceleration data for our subsets, which satisfy a dynamical property. In Section 3, we explain a controlled way of choosing acceleration data, and immediately show the Mayer-Vietoris property for two domains with non-intersecting boundary in Section 4. Sections 5-7 are the main technical sections: they discuss barriers, and how they can be used to prove our main theorem (Theorem 5.7.1). In Section 8, we give examples of barriers. In Section 9, after generalizing the main theorem slightly (Theorem 5.9.1), we consider the involutive case, and show the descent result for multiple subsets.

In Appendix A, we establish the easy translation from Pardon's simplicial diagrams to our cubical ones. Finally, in Appendix B, we reduce the descent statement for $n > 2$ subsets to a bunch of others but each involving only 2 subsets.

The reader who is interested mainly in the Mayer-Vietoris property and has background in Hamiltonian Floer theory can take a look at the conventions in the beginning of Chapter 4, and jump ahead to Chapter 5.

Chapter 2

Algebra preparations

2.1 Commutative algebra over the Novikov ring

Let us start by writing down our conventions for the Novikov field:

$$\Lambda = \left\{ \sum_{i \in \mathbb{N}} a_i T^{\alpha_i} \mid a_i \in \mathbb{Q}, \alpha_i \in \mathbb{R}, \text{ and for any } R \in \mathbb{R}, \right. \quad (2.1.0.1)$$

$$\left. \text{there are only finitely many } a_i \neq 0 \text{ with } \alpha_i < R \right\} \quad (2.1.0.2)$$

There is a valuation map $val : \Lambda \rightarrow \mathbb{R} \cup \{+\infty\}$ given by $val(\sum_{i \in \mathbb{N}} a_i T^{\alpha_i}) = \min_i(\alpha_i \mid a_i \neq 0)$ for non zero elements, and $val(0) = +\infty$. We define $\Lambda_{\geq r} := val^{-1}([r, \infty])$ and $\Lambda_{> r} := val^{-1}((r, \infty])$. $\Lambda_{\geq 0}$ is called the Novikov ring. The valuation we described makes $\Lambda_{\geq 0}$ a complete valuation ring with real numbers as the value group. The following lemma follows easily.

Lemma 2.1.1. *1. All submodules of Λ as a $\Lambda_{\geq 0}$ -module are given by $0, \Lambda, \Lambda_{\geq r}$, and $\Lambda_{> r}$ for $r \in (-\infty, \infty)$.*

2. $\Lambda_{\geq 0}$ is a local ring with maximal ideal $\Lambda_{> 0}$, fraction field Λ , and residue field $\Lambda_{\geq 0}/\Lambda_{> 0} = \mathbb{Q}$.

Note that $\Lambda_{\geq 0}$ is not a PID since $\Lambda_{>0}$ is not a principal ideal. Let us list some properties of modules over the Novikov ring.

Lemma 2.1.2. *Let A be a $\Lambda_{\geq 0}$ -module.*

1. *A is flat if and only if it is torsion free.*
2. *A is projective if and only if it is free.*
3. *Assume that A is finitely generated. Then A is a direct sum of cyclic modules. In particular, A is free if and only if it is torsion free.*

Proof. 1. This is true for any valuation ring [34, Tag 0539]

2. This is true for any local ring [34, Tag 058Z].

3. This is true for any almost maximal valuation ring [17].

□

2.1.1 Acyclicity of chain complexes over $\Lambda_{\geq 0}$

In this section an abelian group C with an endomorphism $d : C \rightarrow C$ such that $d^2 = 0$ is called a chain complex. If a chain complex C is a $\Lambda_{\geq 0}$ -module, and d is a module homomorphism, we say that C is over $\Lambda_{\geq 0}$.

Here is the main result of this section:

Lemma 2.1.3. *Let C be a chain complex over $\Lambda_{\geq 0}$. Assume that the module underlying C is free and finite rank. Then,*

- *$H(C)$ is a finitely generated $\Lambda_{\geq 0}$ -module.*
- *C is acyclic if and only if $C \otimes_{\Lambda_{\geq 0}} \Lambda_{\geq 0}/\Lambda_{>0}$ is acyclic.*

Proof. First, note that the image $d(C) \subset C$ is a finitely generated torsion free module. Hence, it is also free, so the exact sequence:

$$0 \rightarrow \ker(d) \rightarrow C \rightarrow d(C) \rightarrow 0 \quad (2.1.1.1)$$

splits. Therefore $\ker(d)$ is projective, hence free. It also follows that it is finitely generated. This proves the first bullet point.

For the second statement, note that since C is flat, we have a short exact sequence of complexes:

$$0 \rightarrow C \otimes_{\Lambda_{\geq 0}} \Lambda_{>0} \rightarrow C \rightarrow C \otimes_{\Lambda_{\geq 0}} \Lambda_{\geq 0}/\Lambda_{>0} \rightarrow 0, \quad (2.1.1.2)$$

which induces a periodic long exact sequence (i.e. an exact triangle):

$$\dots \rightarrow H(C \otimes_{\Lambda_{\geq 0}} \Lambda_{>0}) \rightarrow H(C) \rightarrow H(C \otimes_{\Lambda_{\geq 0}} \Lambda_{\geq 0}/\Lambda_{>0}) \rightarrow \dots \quad (2.1.1.3)$$

Note that $H(C \otimes_{\Lambda_{\geq 0}} \Lambda_{>0}) = H(C) \otimes_{\Lambda_{\geq 0}} \Lambda_{>0}$, and the maps in the long exact sequence are the canonical maps induced by tensoring $\Lambda_{>0} \rightarrow \Lambda_{\geq 0}$, since $\Lambda_{>0}$ is flat.

The only if direction is easy, i.e. if we assume $H(C) = 0$, then $H(C \otimes_{\Lambda_{\geq 0}} \Lambda_{\geq 0}/\Lambda_{>0}) = 0$ by the long exact sequence.

Now assume $H(C \otimes_{\Lambda_{\geq 0}} \Lambda_{\geq 0}/\Lambda_{>0}) = 0$. From the long exact sequence we get:

$$H(C) \otimes_{\Lambda_{\geq 0}} \Lambda_{>0} \rightarrow H(C) \quad (2.1.1.4)$$

is an isomorphism, i.e. $H(C) \otimes_{\Lambda_{\geq 0}} \Lambda_{\geq 0}/\Lambda_{>0} = 0$. Now, invoking Nakayama's lemma using Lemma 2.1.1 (2), we obtain $H(C) = 0$. \square

Remark 2.1.4. *Another (less commutative algebra heavy!) proof of the second part of this lemma is given in Section 2.4, Corollary 2.4.3.*

2.2 Homotopical constructions

In this section we assume that all our chain complexes are $\mathbb{Z}/2$ -graded. However, whenever there is a \mathbb{Z}/N or \mathbb{Z} -grading statements can be modified to take into account those gradings without a problem.

2.2.1 Cubes

Consider the standard unit cube $Cube^n := \{(x_1, \dots, x_n) \mid x_j \in [0, 1]\} \subset \mathbb{R}^n$. Note that the ordering of the coordinates will be part of the data. For $0 \leq k \leq n$, a k -dimensional face of $Cube^n$ is the subset of $Cube^n$ given by setting $n - k$ coordinates to either 0 or 1. Let us call a vertex of a k -face the **initial** vertex if it has the maximum number of zeros and **terminal** if it has the maximum number of ones.

Let us call two faces F' and F'' adjacent if the terminal vertex of F' equals the initial vertex of F'' . We denote this relationship by $F' > F''$. We say that two adjacent faces form a boundary of a face F if F is the smallest face that contains both F' and F'' .

Let R be a commutative ring. We define an n -**cube of chain complexes** over R in the following way. To 0-dimensional faces (i.e. vertices) of $Cube^n$ we associate an R -module C^v , and for any k -dimensional face (including $k = 0$) F we give maps $f_F : C^{\nu_{in}F} \rightarrow C^{\nu_{ter}F}$ from its initial vertex to its terminal vertex, of degree $\dim(F) + 1$.

These maps are required to satisfy the following relations. For each face F we have:

$$\sum_{F' > F'' \text{ is a bdry of } F} (-1)^{*_{F',F}} f_{F'} f_{F''} = 0, \quad (2.2.1.1)$$

where $*_{F',F} = \#_v 1 + \#_v 01$ for $v = \nu_{ter}F' - \nu_{in}F'$ considered as a vector inside F . Let us explain this notation a little bit. The coordinates of v is a sequence of 0's and 1's of length $\dim(F)$. If $abc..$ is a word of 0's and 1's, $\#_v abc..$ is the number of

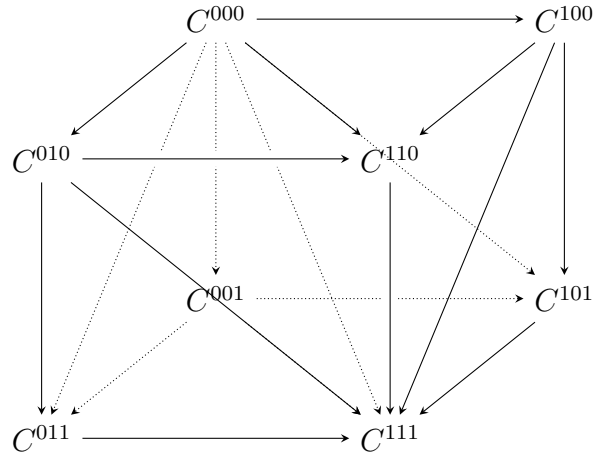

Figure 2-1: A 3-cube

ordered subsequences of the coordinates of v that is equal to $abc\dots$. It's clear how this definition would extend to an alphabet with more letters.

In Figure 2.2.1 we present a 3-cube to illustrate the definition. At the corners there are chain complexes, at the edges chain maps, at the square faces homotopies between the two different ways of going between the initial and terminal vertices of that square, and lastly at the codimension 0 face we have one map H that satisfies:

$$-g^{100} + g^{010} - g^{001} + g^{011} - g^{101} + g^{110} + dH - Hd = 0, \quad (2.2.1.2)$$

where g^{100} is the composition $C^{000} \rightarrow C^{100} \rightarrow C^{111}$ (the second map is the homotopy) etc.

2.2.2 Maps between n -cubes

A partially defined n -cube is one where we have some vertices with chain complexes, and some faces with maps defined so that that whenever it makes sense the Equation 2.2.1.1 is satisfied. If this data is extended to a full n -cube, we call the extension a filling.

We define a map between two n -cubes to be a filling of an $(n + 1)$ -cube where the two opposite faces are the given n -cubes.

$$\mathcal{C} \rightarrow \mathcal{C}' \tag{2.2.2.1}$$

An example of a map of n -cubes is the *id* map, where the two n -cubes are connected to each other with identity maps between the chain complexes and all the homotopies are zero. Note that this works no matter where we add the extra coordinate in the ordering.

A homotopy of two maps of n -cubes is a filling of an $(n + 2)$ -cube where two opposite faces are the given $(n + 1)$ -cubes (i.e. maps) and the copies of each given n -cube at those opposite faces are connected to each other with identity maps. Here we require that the *id*-coordinate is the last of the $n + 2$ coordinates.

$$\begin{array}{ccc} \mathcal{C} & \longrightarrow & \mathcal{C}' \\ \downarrow id & & \downarrow id \\ \mathcal{C} & \longrightarrow & \mathcal{C}' \end{array} \tag{2.2.2.2}$$

Let us call an $(n + 2)$ -cube of such shape an $(n + 2)$ -slit.

A triangle of maps of n -cubes is a triple of n -cubes and maps between them placed in a partial $(n + 2)$ cube in the following manner, and of course a filling of that cube. Again we require that the *id*-coordinate is the last of the $n + 2$ coordinates.

$$\begin{array}{ccc} \mathcal{C} & \longrightarrow & \mathcal{C}'' \\ \downarrow & & \downarrow id \\ \mathcal{C}' & \longrightarrow & \mathcal{C}'' \end{array} \tag{2.2.2.3}$$

Let us call an $n + 2$ -cube of such shape an $n + 2$ -triangle.

We now give examples of these definitions in low dimensions. Let the following be a diagram of chain complexes that are commutative up homotopy, with g and h

two choices of such homotopies.

$$\begin{array}{ccc}
 C_0 & \xrightarrow{c} & C_1 \\
 f_0 \downarrow & \searrow h & \downarrow f_1 \\
 C'_0 & \xrightarrow{c'} & C'_1
 \end{array} \tag{2.2.2.4}$$

Hence these are two ways of completing the diagram into a 2-cube.

Equivalently, f_0, f_1 and h or g give maps between the 1-cubes c and c' . A homotopy of maps between these two maps is a map $H : C_0 \rightarrow C'_1$ which satisfies, $dH - Hd = g - h$. Clearly this data is equivalent to a 3-cube obtained by taking the two 2-cubes and placing one of them slightly out of the page and connecting the two by identity chain maps and zero homotopies, and filling in the cube with H .

Note that this is not the most general kind of homotopy between two maps of 1-cubes, because the vertical chain maps in both maps of 1-cubes are the same. More generally let f_0, f_1, h and f'_0, f'_1, h' be two different maps of 1-cubes. Then a homotopy between the two would be given by F_0 , a homotopy between f_0 and f'_0 , similarly F_1 , and also an H that satisfies the equation that is associated to the maximal face of the 3-cube:

$$c'F_1 - F_2c + h' - h + dH - Hd = 0, \tag{2.2.2.5}$$

as a special case of Equation 2.2.1.2.

Let us now start with a homotopy commutative triangle, i.e.

$$\begin{array}{ccc}
 C_0 & \xrightarrow{f_0} & C_1 \\
 & \searrow g & \downarrow f_1 \\
 & & C_2
 \end{array} , \tag{2.2.2.6}$$

and another map that fills the triangle $h : C_0 \rightarrow C_2$, which satisfies

$$f_1 f_0 - g + dh + hd = 0. \quad (2.2.2.7)$$

We like to think of this as the following 2-cube:

$$\begin{array}{ccc} C_0 & \xrightarrow{f_0} & C_1 \\ \downarrow g & \searrow h & \downarrow f_1 \\ C_2 & \xrightarrow{id} & C_2 \end{array} \quad (2.2.2.8)$$

2.2.3 n -cubes with positive signs

There is a slightly different definition of n -cubes where the signs are not present. We define an **n -cube with positive signs** to be one where the signs in the Equation 2.2.1.1 are all $+1$, in other words $* = 0$.

Faces of $Cube_n$ are in one-to-one correspondence with

$$\{(i_1, \dots, i_n) \mid i_k \in \{0, 1, -\}\}, \quad (2.2.3.1)$$

where $-$ represents the coordinates that vary in the face. Let us denote this assignment by $F \mapsto \mu(F)$.

Lemma 2.2.1. *Let (C_v, f_F) be an n -cube ($f_{\{v\}}$ are the differentials). There exists a canonical (but not unique) way of changing the signs of $f_F \mapsto (-1)^{n(F)} f_F$ so that $(C_v, (-1)^{n(F)} f_F)$ is an n -cube with positive signs.*

Proof. We define $n(F) := \#_{\mu(F)}(0-) + \#_{\mu(F)}0$.

Let $F' > F''$ be a boundary of F . Let $S \subset [n]$ be the entries of $\mu(F)$ that are equal to $-$. Then, there is a subset $S' \subset S$ such that $\mu(F')$ is obtained by changing the entries of S corresponding to S' to 0 , and $\mu(F'')$ is obtained by changing the entries corresponding to $S - S'$ to 1 .

We claim that $\#_{\mu(F)}(0-) + n(F') + n(F'') + *_{F',F}$ is even. The parity of $\#_{\mu(F)}(0-) + \#_{\mu(F')}(0-) + \#_{\mu(F'')}(0-)$ is equal to the one of the number of 01's in $\nu_{ter}F' - \nu_{in}F'$ considered as a vector inside F . Moreover the one of the number of 1's in $\nu_{ter}F' - \nu_{in}F'$ considered as a vector inside F plus $\#_{\mu(F')}0 + \#_{\mu(F'')}0$ has the same parity as $\dim F$. This proves the claim because the overall factor $(-1)^{\#_{\mu(F)}(0-) + \dim F}$ can be canceled from the equation. \square

2.2.4 Cones of n -cubes

Recall that the usual cone operation takes a chain map (i.e. a 1-cube) between two chain complexes, and spits out a single chain complex (a 0 cube):

$$(C, d) \xrightarrow{f} (C', d') \longrightarrow \left[C[1] \oplus C', \begin{pmatrix} -d & 0 \\ f & d' \end{pmatrix} \right]. \quad (2.2.4.1)$$

This can be generalized to all cubes. First, given an n -cube with positive signs and one of the n directions, we can construct an $(n-1)$ -cube with positive signs by the cone construction. The chain complexes at the vertices are given by the standard cone construction, and the maps are defined in the only possible way without losing any data.

More precisely, let (C_v, f_F) be an n -cube with positive signs, and $1 \leq i \leq n$ an integer. If w is a sequence of length $n-1$, we let (w, i, a) be the sequence of length n with a added as the i th entry to w . Recall also that we can identify a face F by $\mu(F)$ as defined in the previous subsection.

Now the cone of (C_v, f_F) in direction i is defined by:

$$C_w = C_{(w,i,0)}[1] \oplus C_{(w,i,1)}, \quad (2.2.4.2)$$

and $f_F : C_{in(F)} \rightarrow C_{ter(F)}$ is given by the matrix,

$$\begin{pmatrix} f_{(\mu(F),i,0)} & 0 \\ f_{(\mu(F),i,-)} & f_{(\mu(F),i,1)} \end{pmatrix} \quad (2.2.4.3)$$

It is readily seen that this defines an $(n - 1)$ -cube with positive signs.

Now, we define cones on n -cubes by

$$n - \text{cube} \rightarrow n - \text{cube with p. signs} \rightarrow (n - 1) - \text{cube with p. signs} \rightarrow (n - 1) - \text{cube} \quad (2.2.4.4)$$

Note that the signs in the formulas will be different for different directions. We will call the fact that the cone operation turns an n -cube into an $(n - 1)$ -cube, the **functoriality of the cone operation**.

Lemma 2.2.2. *1. Iterations of the cone construction in any ordering of the n directions gives a chain complex, which is independent of the order.*

2. Assume that id is the last coordinate in the $(n + 1)$ -cube $\mathcal{C} \xrightarrow{id} \mathcal{C}$. Then the cone operation in any other direction d gives $\text{cone}^d(\mathcal{C}) \xrightarrow{id} \text{cone}^d(\mathcal{C})$. In particular, cones in directions except the last one send n -slits to n -slits, and n -triangles to n -triangles.

Proof. 1. If $\mu(F)$ is as in the proof of Lemma 2.2.1, then the sign in front of f_F in the end will be $\#_{\mu(F)}0 + \#_{\mu(F)}0-$.

2. The identity maps do not change sign because if the d th entry is 0 then they get negated twice, and if it is 1 not at all. The two opposite faces (connected by id) get the same sign changes because their last coordinates being 0 or 1 do not matter to the sign change.

□

We explain this on 2-cubes. There are two cones of the 2-cube with h as the filling in Diagram 2.2.2.4 (called \mathcal{C}), one that takes the f 's as the maps $\text{cone}^f(C)$, and one that sees c 's as maps $\text{cone}^c(C)$ (which we called directions in Lemma 2.2.2). Assume that c is the first coordinate. Let us write them down explicitly.

$$\text{cone}^f(C) = \left[C_0[1] \oplus C'_0, \begin{pmatrix} -d & 0 \\ -f_1 & d \end{pmatrix} \right] \xrightarrow{\begin{pmatrix} -c & 0 \\ h & c' \end{pmatrix}} \left[C_1[1] \oplus C'_1, \begin{pmatrix} -d & 0 \\ f_2 & d \end{pmatrix} \right] \quad (2.2.4.5)$$

$$\text{cone}^c(C) = \left[C_0[1] \oplus C_1, \begin{pmatrix} -d & 0 \\ c & d \end{pmatrix} \right] \xrightarrow{\begin{pmatrix} f_1 & 0 \\ h & f_2 \end{pmatrix}} \left[C'_0[1] \oplus C'_1, \begin{pmatrix} -d & 0 \\ c & d \end{pmatrix} \right] \quad (2.2.4.6)$$

Taking the cone in the remaining direction results in $C_0 \oplus (C_1[1] \oplus C'_0[1]) \oplus C'_1$ with differential:

$$\begin{pmatrix} d & 0 & 0 & 0 \\ -c & -d & 0 & 0 \\ f_1 & 0 & -d & 0 \\ h & c' & f & d \end{pmatrix}. \quad (2.2.4.7)$$

2.2.5 Composing n -cubes

The composition of two chain maps is a chain map. We generalize this construction to higher dimensional cubes.

Let us start with 2-cubes. Let the two squares below be commutative up to the

given homotopies.

$$\begin{array}{ccccc}
 C_0 & \xrightarrow{c_0} & C_1 & \xrightarrow{c_1} & C_2 \\
 f_0 \downarrow & \searrow g_0 & f_1 \downarrow & \searrow g_1 & f_2 \downarrow \\
 D_0 & \xrightarrow{d_0} & D_1 & \xrightarrow{d_1} & D_2
 \end{array} \tag{2.2.5.1}$$

In this case, we say that the two 2-cubes are glued along f_1 a 1-cube.

We can define the composite 2-cube: .

$$\begin{array}{ccc}
 C_0 & \xrightarrow{c_1 c_0} & C_2 \\
 f_0 \downarrow & \searrow G & f_2 \downarrow \\
 D_0 & \xrightarrow{d_1 d_0} & D_2
 \end{array} \tag{2.2.5.2}$$

where $G = g_1 c_0 + g_0 c_1$.

In general, if we are given two n -cubes glued along an $(n-1)$ -cube, we can define an n -cube in a similar fashion. This operation also depends on the ordering (i.e. the place of the special direction in the ordering).

First note that any iterated cone of an n -cube (remembering its direct sum decomposition) has the same information as the cone itself. Only some signs are different but we know exactly how the signs change.

Let $\mathcal{C} \rightarrow \mathcal{C}' \rightarrow \mathcal{C}''$ be two n -cubes $\mathcal{C} \rightarrow \mathcal{C}'$ and $\mathcal{C}' \rightarrow \mathcal{C}''$ glued along \mathcal{C}' . By taking the $(n-1)$ times iterated cone we get two chain maps glued along a chain complex $\text{cone}^{n-1}(\mathcal{C}) \rightarrow \text{cone}^{n-1}(\mathcal{C}') \rightarrow \text{cone}^{n-1}(\mathcal{C}'')$. We of course know how to compose these two maps, and all we need to do is to de-cone this as described in the previous paragraph. We omit the explicit formulas. The following is immediate by definition.

Lemma 2.2.3. • *The composition operation is associative. Namely if we have three cubes glued along linearly, then the final composition is independent of the order in which we performed the compositions.*

- *Composition commutes with the cone operation done in a direction parallel to the glued face.*

2.2.6 Rays

We call an infinite sequence of n -cubes $\mathcal{D}_1, \mathcal{D}_2, \dots$ an n -ray if they are glued together to form a half-infinite box, more precisely an $(n - 1)$ -dimensional face of \mathcal{D}^1 is the same as one of \mathcal{D}_2 , the opposite face of \mathcal{D}_2 is the same as one of \mathcal{D}_3 , etc. Below is a 1-ray:

$$C_0 \rightarrow C_1 \rightarrow C_2 \rightarrow \dots \quad (2.2.6.1)$$

And a 2-ray:

$$\begin{array}{ccccccc}
 C_0 & \xrightarrow{c_0} & C_1 & \xrightarrow{c_1} & C_2 & \longrightarrow & \dots \\
 f_0 \downarrow & \searrow g_0 & f_1 \downarrow & \searrow g_1 & f_2 \downarrow & \searrow & \\
 D_0 & \xrightarrow{d_0} & D_1 & \xrightarrow{d_1} & D_2 & \longrightarrow & \dots
 \end{array} \quad (2.2.6.2)$$

For an n -ray, there are $n - 1$ finite, and 1 infinite directions. We always think of the infinite direction as the first in order. We call the faces of the n -cubes forming an n -ray that are perpendicular to the infinite direction the slices of the ray. Slices are $(n - 1)$ -cubes. An n -ray can be presented as

$$\mathcal{C}_0 \rightarrow \mathcal{C}_1 \rightarrow \mathcal{C}_2 \rightarrow \dots, \quad (2.2.6.3)$$

where \mathcal{C}_i are the slices, and the n -cubes forming the n -ray are seen as maps between the slices.

We define a map between two n -rays to be an $(n + 1)$ -ray filling the two n -rays, in other words, $n + 1$ -cubes filling the two infinite sequence of n -cubes which glue

together. The 2-ray above is map between the upper and lower 1-rays.

A homotopy between two maps of n -rays is again given by a sequence of homotopies for the given maps of n -cubes that glue together. A triangle of maps is defined in the same way.

2.2.7 Cones and telescopes of n -rays

By results of the previous section, along the $n - 1$ finite directions we can take cones and end up with an $(n - 1)$ -ray.

Let $\mathcal{C} = C_0 \rightarrow C_1 \rightarrow C_2 \rightarrow \dots$ be a 1-ray. The telescope $tel(\mathcal{C})$ of such a diagram is defined to be the R -module $\bigoplus_{i \in \mathbb{N}} C_i[1] \oplus C_i$ with the differential as depicted below:

$$\begin{array}{ccccc}
 \begin{array}{c} \curvearrowright \\ d \\ C_0 \end{array} & & \begin{array}{c} \curvearrowright \\ d \\ C_1 \end{array} & & \begin{array}{c} \curvearrowright \\ d \\ C_2 \end{array} \\
 \text{id} \uparrow & \nearrow & \text{id} \uparrow & \nearrow & \text{id} \uparrow \cdots \\
 C_0[1] & & C_1[1] & & C_2[1] \\
 \begin{array}{c} \curvearrowleft \\ -d \end{array} & & \begin{array}{c} \curvearrowleft \\ -d \end{array} & & \begin{array}{c} \curvearrowleft \\ -d \end{array}
 \end{array} \tag{2.2.7.1}$$

More generally, the telescope $tel(\mathcal{C})$ of an n -ray \mathcal{C} is an $(n - 1)$ -cube. Let \mathcal{C} be the n -ray $C_0 \rightarrow C_1 \rightarrow C_2 \rightarrow \dots$. Now define the R -modules at the vertices of $tel(\mathcal{C})$ as the entrywise direct sum $\bigoplus_{i \in \mathbb{N}} C_i[1] \oplus C_i$. The maps in the $(n - 1)$ -cube structure are depicted in:

$$\begin{array}{ccccc}
 C_0 & & C_1 & & C_2 \\
 \text{id} \uparrow & \nearrow & \text{id} \uparrow & \nearrow & -\text{id} \uparrow \cdots \\
 \pm C_0[1] & & \pm C_1[1] & & \pm C_2[1]
 \end{array} \tag{2.2.7.2}$$

Note that the C_i 's (and the shifted copies) have internal structure that make them an $(n - 1)$ -cube that is taken into account here, and the \pm in front means that some

those maps are negated (as described in the next sentence). The pieces formed by diagonal arrows are the cones of $\mathcal{D}_i = \mathcal{C}_{i-1} \rightarrow \mathcal{C}_i$'s in the infinite direction, and the vertical arrows are the cones of $\mathcal{C}_i \xrightarrow{id} \mathcal{C}_i$, where id is put as the first coordinate. In particular, the fact that this is an $(n-1)$ -cube follows from the functoriality of cones.

Lemma 2.2.4. • *We get a canonical 1-ray from any n -ray by an $(n-1)$ times iterated cone. This commutes with the telescope.*

- *Telescopes are functorial in the sense that (1) a map of n -rays canonically give a map of the telescopes (which are $(n-1)$ -cubes), (2) a homotopy between two maps give a homotopy, (3) a triangle of maps gives a triangle of maps.*

2.3 1-rays and quasi-isomorphisms

In this section we give a low level discussion of the fact that the telescope of a 1-ray is the homotopy colimit of the diagram in the appropriate category of chain complexes. Let $\mathcal{C} = C_0 \rightarrow C_1 \rightarrow C_2 \rightarrow \dots$ be a 1-ray.

Lemma 2.3.1. *There is a canonical quasi-isomorphism*

$$tel(\mathcal{C}) \rightarrow \lim_{\rightarrow} (C_1 \rightarrow C_2 \rightarrow \dots) \tag{2.3.0.1}$$

Proof. Define $F^n(tel(\mathcal{C}))$ to be $(\bigoplus_{i \in [1, n-1]} C_i[1] \oplus C_i) \oplus C_n$. Notice that $tel(\mathcal{C})$ is the usual direct limit of $F^n(tel(\mathcal{C}))$. Moreover, there are canonical quasi-isomorphisms $F^n(\mathcal{C}) \rightarrow C_n$ induced by the given maps $C_i \rightarrow C_n$, $i \in [1, n]$ and the zero maps $C_i[1] \rightarrow C_n$, $i \in [1, n-1]$, which makes the diagrams

$$\begin{array}{ccc} F^n(tel(\mathcal{C})) & \longrightarrow & F^{n+1}(tel(\mathcal{C})), \\ \downarrow & & \downarrow \\ C_n & \longrightarrow & C_{n+1} \end{array}, \tag{2.3.0.2}$$

commutative. The induced map $tel(\mathcal{C}) \rightarrow \lim_{\rightarrow} C_i$ is also a quasi-isomorphism, since direct limits commute with homology. \square

Let $i(0) < i(1) < i(2) < \dots$ be a subset of N . Note that by composing maps we get a unique map $C_n \rightarrow C_m$ for all $m \geq n$. Then we canonically obtain a 1-ray $\mathcal{C}^i = C_{i(1)} \rightarrow C_{i(2)} \rightarrow \dots$. Let us call this a subray. Let us call the canonical map of 1-rays $\mathcal{C} \rightarrow \mathcal{C}^i$ a compression map:

$$\begin{array}{ccccccc} C_1 & \longrightarrow & C_2 & \longrightarrow & C_3 & \longrightarrow & \dots \\ \downarrow & & \downarrow & & \downarrow & & \\ C_{i(1)} & \longrightarrow & C_{i(2)} & \longrightarrow & C_{i(3)} & \longrightarrow & \dots \end{array} \quad (2.3.0.3)$$

Lemma 2.3.2. *The compression map induces a quasi-isomorphism: $tel(\mathcal{C}) \rightarrow tel(\mathcal{C}^i)$.*

Proof. This follows from the commutativity of the diagram:

$$\begin{array}{ccc} tel(\mathcal{C}) & \longrightarrow & tel(\mathcal{C}^i) \\ \downarrow & & \downarrow \\ \lim_{\rightarrow}(C_1 \rightarrow C_2 \rightarrow \dots) & \longrightarrow & \lim_{\rightarrow}(C_{i(1)} \rightarrow C_{i(2)} \rightarrow \dots) \end{array} \quad , \quad (2.3.0.4)$$

since bottom horizontal map is a quasi-isomorphism, using that the homology commutes with direct limits and that i is a cofinal subsequence of natural numbers. \square

This generalizes to higher dimensional rays too. Using Subsection 2.2.5 we can define the notion of subrays, and compression morphisms in exactly the same way. The lemma above holds with tel replaced by $tel \circ cone^{n-1}$ by definition of composition.

2.4 Completion of modules and chain complexes over the Novikov ring

Completion is a functor $Mod(\Lambda_{\geq 0}) \rightarrow Mod(\Lambda_{\geq 0})$ defined by

$$A \mapsto \widehat{A} : \varprojlim_{r \geq 0} A \otimes_{\Lambda_{\geq 0}} \Lambda_{\geq 0} / \Lambda_{\geq r}, \quad (2.4.0.1)$$

and by functoriality of inverse limits on the morphisms. There is a natural map of modules $A \rightarrow \widehat{A}$.

One can construct the completion in the following way. Let us say that a sequence (a_1, a_2, \dots) of elements of A

- is a **Cauchy sequence** if for every $r \geq 0$ there exists a positive integer N such that for every $n, n' > N$, $a_n - a_{n'} \in T^r A$,
- **converges** to $a \in A$ if for every $r \geq 0$ there exists a positive integer N such that for every $n > N$, $a - a_n \in T^r A$.

Then, we have that \widehat{A} is isomorphic to all Cauchy sequences in M (with its natural $\Lambda_{\geq 0}$ -module structure) modulo the ones that converge to 0.

In case A is free, this description becomes simpler. Choose a basis $\{v_i\}$, $i \in \mathcal{I}$. Then, \widehat{A} is isomorphic to

$$\left\{ \sum_{i \in \mathcal{I}} \beta_i v_i \mid \beta_i \in \Lambda_{\geq 0}, \text{ and for every } R \geq 0, \text{ there is only} \right. \quad (2.4.0.2)$$

$$\left. \text{finitely many } i \in \mathcal{I} \text{ s.t. } \text{val}(\beta_i) < R \right\}. \quad (2.4.0.3)$$

The following lemma is immediate from this description.

Lemma 2.4.1. *Let A be a free $\Lambda_{\geq 0}$ -module. Then*

- \widehat{A} is torsion free (i.e. flat).
- The map $A \otimes_{\Lambda_{\geq 0}} \Lambda_{\geq 0}/\Lambda_{\geq r} \rightarrow \widehat{A} \otimes_{\Lambda_{\geq 0}} \Lambda_{\geq 0}/\Lambda_{\geq r}$ is an isomorphism for all $r \geq 0$.

The completion functor automatically extends to a functor $Ch(\Lambda_{\geq 0}) \rightarrow Ch(\Lambda_{\geq 0})$.

Lemma 2.4.2. *Let C be a chain complex over $\Lambda_{\geq 0}$.*

- If C is torsion free, then $C \otimes_{\Lambda_{\geq 0}} \Lambda_{\geq 0}/\Lambda_{\geq r}$ is acyclic if C is acyclic.
- If C is torsion-free and complete (meaning that every Cauchy sequence converges), and $r > 0$, then $C \otimes_{\Lambda_{\geq 0}} \Lambda_{\geq 0}/\Lambda_{\geq r}$ is acyclic only if C is acyclic.

Proof. The first bullet point follows from the long exact sequence of the short exact sequence:

$$0 \rightarrow C \xrightarrow{T^r} C \rightarrow C \otimes_{\Lambda_{\geq 0}} \Lambda_{\geq 0}/\Lambda_{\geq r} \rightarrow 0. \quad (2.4.0.4)$$

For the second one, let $\alpha \in C$, and $d\alpha = 0$. We need to show that α is exact. Our assumption implies that there exists an $a, b \in C$ such that $\alpha = db + T^r a$.

We have that $d(T^r a) = T^r da = 0$, which implies that $da = 0$ by torsion-freeness. Now we repeat the previous step for a , and keep going. Because of our completeness assumption this defines a primitive of α . \square

Corollary 2.4.3. *1. Assume that C is finitely generated free, then if $C \otimes_{\Lambda_{\geq 0}} \Lambda_{\geq 0}/\Lambda_{>0}$ is acyclic then so is C .*

2. Assume that C is free, then C acyclic implies \widehat{C} acyclic.

3. Let $f : C \rightarrow C'$ be a chain map. Assume that the underlying modules of C and C' are flat. Then $\widehat{f} : \widehat{C} \rightarrow \widehat{C}'$ is a quasi-isomorphism if f is one.

Proof. For (1), choose a basis for C and write d as a matrix. There exists a smallest positive number r such that T^r has a non-zero coefficient in a matrix entry. Then our assumption actually implies that $C \otimes_{\Lambda_{\geq 0}} \Lambda_{\geq 0}/\Lambda_{\geq r}$ is acyclic.

For (2), combine the previous two lemmas (noting that the completion of a module is complete), and for (3) use the fact a chain map is a quasi-isomorphism if its cone is acyclic. \square

Even though taking homotopy colimits are better suited for general constructions, sometimes usual direct limits are better for computations. To this end we show that Lemma 2.3.1 still holds after completions.

Lemma 2.4.4. *Let $\mathcal{C} = C_0 \rightarrow C_1 \rightarrow C_2 \rightarrow \dots$ be a 1-ray. There is a canonical quasi-isomorphism*

$$\widehat{tel(\mathcal{C})} \rightarrow \widehat{\lim_{\rightarrow}(\mathcal{C})}. \quad (2.4.0.5)$$

Proof. We have canonical quasi-isomorphisms

$$f_r : tel(\mathcal{C}) \otimes_{\Lambda_{\geq 0}} \Lambda_{\geq 0}/\Lambda_{\geq r} \rightarrow \lim_{\rightarrow}(\mathcal{C}) \otimes_{\Lambda_{\geq 0}} \Lambda_{\geq 0}/\Lambda_{\geq r}, \quad (2.4.0.6)$$

that are compatible with each other, using Lemma 2.3.1 and that tensor product commutes with telescopes and direct limit. We claim that the inverse limit over r of these maps give the desired map.

We show that the inverse limit of $cone(f_r)$ is acyclic, which is clearly enough. Note that the maps in this inverse system are all surjective. Therefore we have a Milnor short exact sequence (see Theorem 3.5.8 in [40]), and the fact that $cone(f_r)$'s are acyclic implies the desired acyclicity. \square

2.5 Acyclic cubes and an exact sequence

Starting from an n -ray we can obtain a $(n - 1)$ -cube by applying telescope. We can then apply completion functor to the result. Hence, we obtain an assignment $\widehat{tel} : (n - rays) \rightarrow ((n - 1) - cubes)$. This trivially extends to morphisms, and

respects homotopies. It is functorial in the sense that it also preserves triangles. We can also apply the maximally iterated cone functor to obtain a chain complex. In fact we could have applied it before the other two operations and the result would not change: $\widehat{\text{cone}^{n-1} \circ \text{tel}} = \widehat{\text{cone}^{n-1}} \circ \widehat{\text{tel}} = \widehat{\text{tel}} \circ \widehat{\text{cone}^{n-1}}$. Note that completion is always applied after telescope.

Lemma 2.5.1. *Assume that we have an $(n + 2)$ -triangle of rays*

$$\begin{array}{ccc} \mathcal{R} & \xrightarrow{f} & \mathcal{R}'' \\ \downarrow & & \downarrow \text{id} \\ \mathcal{R}' & \longrightarrow & \mathcal{R}'' \end{array}, \quad (2.5.0.1)$$

where \mathcal{R}'' is a subray of \mathcal{R} , and there is $(n + 2)$ -slit of rays

$$\begin{array}{ccc} \mathcal{R} & \xrightarrow{f} & \mathcal{R}'' \\ \downarrow \text{id} & & \downarrow \text{id} \\ \mathcal{R} & \xrightarrow{\text{compr.}} & \mathcal{R}'' \end{array}. \quad (2.5.0.2)$$

Then, the composition

$$\text{tel} \circ \text{cone}^n(\mathcal{R}) \rightarrow \text{tel} \circ \text{cone}^n(\mathcal{R}') \rightarrow \text{tel} \circ \text{cone}^n(\mathcal{R}'') \quad (2.5.0.3)$$

is quasi-isomorphism. Assuming that all the underlying modules are free, this stays a quasi-isomorphism after completion.

Let us call an n -cube **acyclic** if its maximally iterated cone is an acyclic chain complex. Note that by Lemma 2.1.3, if the modules in this cube are finitely generated free, then this acyclicity is equivalent to acyclicity after tensoring with the residue field.

Lemma 2.5.2. *Let \mathcal{C} be a n -ray where the underlying modules are free. Assume that*

all the slices are acyclic $(n - 1)$ -cubes, then $\text{tel}(\mathcal{C})$ is acyclic, and hence $\widehat{\text{tel}}(\mathcal{C})$ is also acyclic.

Proof. The first follows because the maximally iterated cone commutes with the telescope functor, and Lemma 2.3.1. The second part is Lemma 2.1.3. \square

Lemma 2.5.3. *An acyclic 2-cube*

$$\begin{array}{ccc}
 C_{00} & \longrightarrow & C_{10} \\
 \downarrow & \searrow & \downarrow \\
 C_{01} & \longrightarrow & C_{11}
 \end{array} . \tag{2.5.0.4}$$

gives rise to an exact sequence,

$$\begin{array}{ccc}
 H(C_{00}) & \longrightarrow & H(C_{10}) \oplus H(C_{01}) \\
 \uparrow [1] & \swarrow & \\
 H(C_{11}) & &
 \end{array} . \tag{2.5.0.5}$$

where the degree preserving arrows are induced from the ones in the 2-cube.

Proof. The acyclicity implies that $C_{00} \rightarrow \text{cone}(C_{10} \oplus C_{01} \rightarrow C_{11})$ is a quasi-isomorphism. Then the long exact sequence of homology associated to the cone finishes the proof. \square

Chapter 3

Definition and Basic properties

In this chapter, we assume familiarity with Hamiltonian Floer theory at the level of Salamon [32], and Pardon [29], Section 10. We also freely use notations and results of the previous chapter.

3.1 Conventions

In this short Section we put together our conventions setting up Hamiltonian Floer theory.

1. $\omega(X_H, \cdot) = dH$
2. $\omega(\cdot, J\cdot) = g$, hence $JX_H = \text{grad}_g H$
3. Floer equation: $J \frac{\partial u}{\partial s} = \frac{\partial u}{\partial t} - X_H$.
4. Topological energy of (arbitrary) $u : S^1 \times \mathbb{R} \rightarrow M$ for a given Hamiltonian

$S^1 \times \mathbb{R} \times M \rightarrow \mathbb{R}$:

$$\int \omega + \int \partial_s(H(s, t, u(s, t)))dsdt \quad (3.1.0.1)$$

$$= \int \omega\left(\frac{\partial u}{\partial s}, \frac{\partial u}{\partial t}\right)dsdt + \int [(\partial_s H_s) + d_{u(s,t)}H_{s,t}\left(\frac{\partial u}{\partial s}\right)]dsdt \quad (3.1.0.2)$$

$$= \int \omega\left(\frac{\partial u}{\partial s}, \frac{\partial u}{\partial t} - X_H\right)dsdt + \int (\partial_s H_s)dsdt \quad (3.1.0.3)$$

5. Homomorphisms defined by moduli problems always send the generator of the Floer complex at the negative punctures to the one at the positive puncture.
6. We consider all orbits, not just contractible ones.
7. We always work over $\Lambda_{\geq 0}$. The generators have no action but the solutions of Floer equations are weighted by their topological energy.
8. We use Floer-Hofer's coherent orientations to fix the signs.
9. The generators have $\mathbb{Z}/2$ grading given by the Lefschetz sign, and the Novikov parameter has degree 0.

Remark 3.1.1. *Assume that the minimal Chern number of M is k . Then, all our cochain complexes can be given a $\mathbb{Z}/2k\mathbb{Z}$ -grading (a \mathbb{Z} -grading, if $k = \infty$). All the statements that we prove can be extended to take into account this grading with no extra work.*

Just to spell out our conventions: we define the degree of a non-degenerate one-periodic orbit γ with a cap D to be $\mu_{CZ}(\gamma, D) + n$, where μ_{CZ} is the Conley-Zehnder index of γ using the trivialization given by D and n is half the dimension of M .

Note that in our conventions the differential of a Hamiltonian Floer cochain complex increases the grading. This is because our Floer equation follows a positive gradient flow convention. Finally, we note that, with these conventions, if γ is a non-degenerate constant orbit of an autonomous H with sufficiently small second deriva-

tives at γ , then the degree of γ (with the constant cap) is equal to the number of negative eigenvalues of the Hession of H at γ .

3.2 Hamiltonian Floer theory

Let M be a closed symplectic manifold. Take a one periodic time-dependent Hamiltonian $H : M \times S^1 \rightarrow \mathbb{R}$ with non-degenerate one-periodic orbits $\mathcal{P}(H)$. Then, there exists choices of a compatible almost complex structure J , extra Pardon data P (as in Definition 7.5.3 in [29]), and coherent orientations (as in Appendix C of [29]) so we can define a chain complex over $\Lambda_{\geq 0}$ as follows:

- As a \mathbb{Z}_2 -graded module:

$$CF(H, J, P) = \bigoplus_{\gamma \in \mathcal{P}(H)} \Lambda_{\geq 0} \cdot \gamma, \quad (3.2.0.1)$$

i.e. $CF(H, J, P)$ is freely generated over $\Lambda_{\geq 0}$ by the elements of $\mathcal{P}(H)$. The grading is given by the Lefschetz sign of the fixed point associated to each periodic orbit.

- We define the differential by the formula:

$$d\gamma = \sum_{\gamma', A \in \pi_2(\gamma, \gamma')} \#^{vir} \mathcal{M}(\gamma, \gamma', A, H, J, P) T^{\omega(A) + \int_{S^1} \gamma'^* H dt - \int_{S^1} \gamma^* H dt} \gamma', \quad (3.2.0.2)$$

and extend it $\Lambda_{\geq 0}$ -linearly. Here $\pi_2(\gamma, \gamma')$ denotes homotopy classes of maps $(S^1 \times I, S^1 \times \{0\}, S^1 \times \{1\}) \rightarrow (M, \gamma, \gamma')$. $\#^{vir} \mathcal{M}(\gamma, \gamma', A, H, J, P) \in \mathbb{Q}$ are virtual numbers defined as in Pardon. These are virtual counts of genus 0 nodal curves with two ordered punctures in total, where both punctures are at the same component, mapping into M . The component with punctures is a cylinder

and the restriction of the map to it $u : \mathbb{R} \times S^1 \rightarrow M$ satisfies the equation:

$$J \frac{\partial u}{\partial s} = \frac{\partial u}{\partial t} - X_H, \quad (3.2.0.3)$$

with the asymptotic conditions

$$u(t, s) \rightarrow \begin{cases} \gamma(t), & s \rightarrow -\infty \\ \gamma'(t), & s \rightarrow \infty. \end{cases} \quad (3.2.0.4)$$

The other components of the curve are J -holomorphic spheres. The homotopy class of the map is given by A .

The exponent of T in the formula, $\omega(A) + \int_{S^1} \gamma'^* H dt - \int_{S^1} \gamma^* H dt$, is the topological energy (as in Section 3.1) of u plus the integral of ω along the sphere components. It follows from the well-known computation presented in Section 3.1 that each of these terms, and hence $\omega(A) + \int_{S^1} \gamma'^* H dt - \int_{S^1} \gamma^* H dt$, is always non-negative whenever $\#^{vir} \mathcal{M}(\gamma, \gamma', A, H, J, P) \neq 0$.

For a more careful description of the moduli spaces involved see Definition 10.2.2 for $n = 0$ in [29].

This makes d a degree one $\Lambda_{\geq 0}$ -module map that squares to zero.

Continuing to follow Pardon, we outline what Hamiltonian Floer theory gives us for higher dimensional families of Hamiltonians. It will be more convenient to use cubes, so we give the theory in that framework, instead of the simplicies as Pardon does.

Let $Cube_n = [0, 1]^n \subset \mathbb{R}^n$. Let us consider the Morse function

$$f(x_1, \dots, x_n) = \sum_{i=1}^n \cos(\pi x_i). \quad (3.2.0.5)$$

Critical points of f are precisely the vertices of the cube, and the gradient vector field is tangent to all the strata of the cube.

By an n -**cube of Hamiltonians**, we mean a smooth map $H : Cube_n \rightarrow C^\infty(M \times S^1, \mathbb{R})$, which is constant on an open neighborhood of each of the vertices, and also so that the Hamiltonians at the vertices are non-degenerate. We also choose a $Cube_n$ -family of compatible almost complex structures J , Pardon data P , and coherent orientations. Now, for each face F of the cube we can consider virtual counts $\#^{vir} \mathcal{M}(\gamma, \gamma', A, H, J, P, F)$ of Floer trajectories associated to that face, intuitively counting buildings of bubbled solutions of Equation 3.2.0.3 with (s, t) -dependent H and J prescribed by the gradient flow lines of f (see Figure 3-1 for a picture, and Definition 10.2.2 in [29] for a precise definition). We again weight these counts by their topological energy.

We want to make three remarks about these virtual counts:

- If the compactified moduli space of stable Floer trajectories (as in Definition 10.2.3 iv. of [29]) is empty for some homotopy class, then the virtual count is necessarily zero. In particular, if $\#^{vir} \mathcal{M}(\gamma, \gamma', A, H, J, P, F) \neq 0$, then, by the computation shown in the bullet point numbered 4. of Section 3.1,

$$\omega(A) + \int_{S^1} \gamma'^* H' - \int_{S^1} \gamma^* H \geq \int \left| \frac{\partial u}{\partial s} \right|^2 ds dt + \int (\partial_s H_s) ds dt, \quad (3.2.0.6)$$

such that there exists a broken flow line of f in $Cube_n$ with intermediate vertices v_1, \dots, v_i (possibly equal to each other, $v_{in(F)}$ or $v_{ter(F)}$), and $u : \mathbb{R} \times S^1 \sqcup \dots \sqcup \mathbb{R} \times S^1 \rightarrow M$ is a building of solutions of continuation map equations (as dictated by the broken flow line) from γ to γ_1 , γ_1 to γ_2 , \dots , γ_i to γ' , for some γ_i , a one-periodic orbit of the Hamiltonian at v_i . Note that we have inequality because we are not considering the geometric energy of the bubbles on the right hand side. We have already alluded to a special case of this inequality once in the

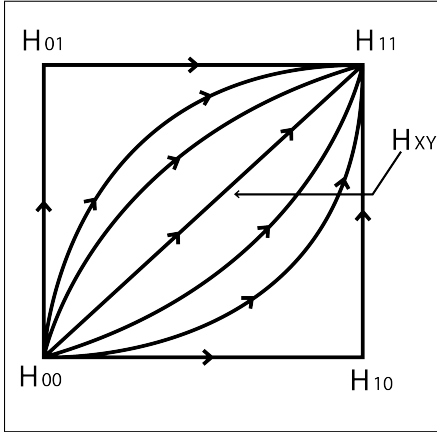

A square family of Hamiltonians as depicted on the left gives rise to a 2-cube of chain complexes as below. Note that the homotopy is defined by counting the accidental solutions in the one parameter family of continuation map equations.

$$\begin{array}{ccc}
 CH(H_{00}) & \longrightarrow & CH(H_{10}) \\
 \downarrow & \searrow & \downarrow \\
 CH(H_{01}) & \longrightarrow & CH(H_{11})
 \end{array} \quad (3.2.0.7)$$

discussion of the differential, where the second term on the right is zero. We call this the **energy inequality**.

- If a compactified moduli space of stable Floer trajectories consists of one point and that point is regular, then the virtual number associated to it is non-zero. This is a consequence of Lemma 5.2.6 of [29].
- If the virtual dimension of a moduli space is not equal to zero, then the virtual counts necessarily give zero.

The upshot for us is that these (weighted) counts fit together to give an n -cube as in the algebra section: the chain complexes at the vertices are the Hamiltonian Floer cochain complexes; at the edges we have what is known as continuation maps; and higher dimensional faces give a hierarchy of homotopies as in the definition of an n -cube. Instead of showing this from scratch, we deduce it from Pardon's results for simplex families in Appendix A.

Remark 3.2.1. *Whenever we pass from a family of Hamiltonians to a diagram of chain complexes we have to make choices of almost complex structures and Pardon data. Our final statements do not depend on these choices. In proofs and constructions all we need is their existence. We can handle these choices in two different ways*

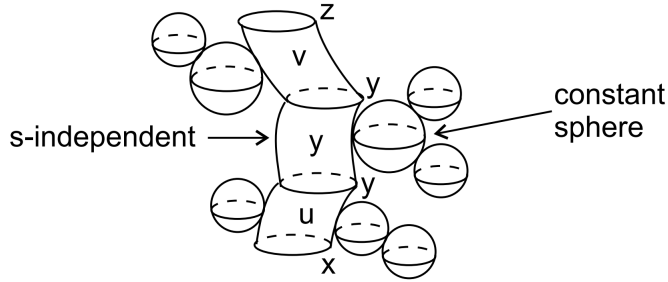

Figure 3-1: Picture of Floer trajectory (taken from Salamon [30])

(1) make a universal choice once and for all, or (2) make the choices inductively whenever you need one as in Pardon [28]. We generally suppress this issue and omit these choices from the labeling of the diagrams.

3.2.1 Monotone families

Definition 4. We call an n -cube family of Hamiltonians **monotone** if the Hamiltonians are non-decreasing along all of the flow lines of f (as defined in (3.2.0.5)). By the energy inequality (3.2.0.6), a monotone n -cube of Hamiltonians gives rise to an n -cube defined over $\Lambda_{\geq 0}$.

We will also use two other shapes $Triangle_n$ and $Slit_n$ which are subsets of $Cube_n$. These are used to define n -triangle and n -slit families of Hamiltonians.

We define $Triangle_2 := \{x_1 \geq x_2\} \subset Cube_2$ and $Slit_2$ to be the closed region that lies between the flow lines of f that pass through the points $(1/3, 2/3)$ and $(2/3, 1/3)$. Then we define $Triangle_n$ and $Slit_n$ by taking cartesian product with $Cube_{n-2}$. The gradient flow of f is tangent to $Triangle_n$ and $Slit_n$ as well. The notion of monotonicity is defined in the same way as we did for the cube. Families of Hamiltonians parametrized by these shapes give rise to special n -cubes as in Subsection 2.2.2:

- $Slit_n$ gives two $(n-2)$ -cubes, two maps between them, and a homotopy between the two maps, i.e. an n -slit.

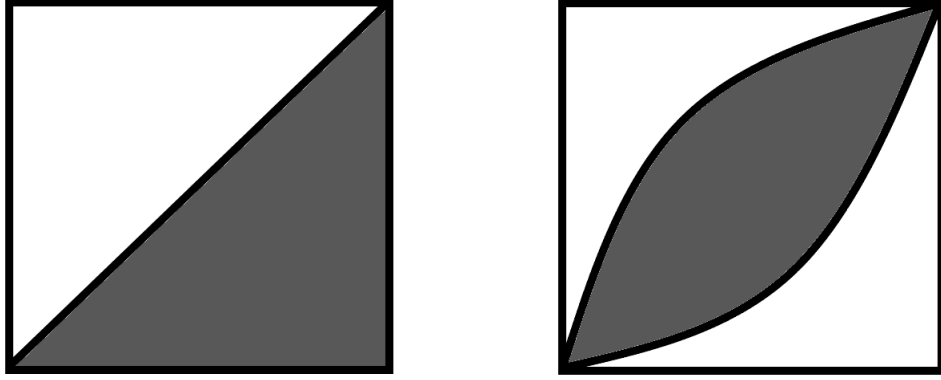

Figure 3-2: On the left is $Triangle_2$ and on the right is $Slit_2$. To obtain $Triangle_n$ and $Slit_n$, we take their product with $Cube_n$

- $Triangle_n$ gives three $(n - 2)$ -cubes, three maps between them as dictated by the connections in the triangle, and a filling of the remainder of the diagram, i.e. an n -triangle.

3.2.2 Contractibility

Definition 5. We define a *homotopy of Hamiltonians with stations* to be a map $h : I \times M \times S^1 \rightarrow \mathbb{R}$, and numbers $s_0 = 0 < s_1 < \dots < s_k < s_{k+1} = 1$ such that the Hamiltonians $H|_a$, for $a \in \{0, s_1, \dots, s_k, 1\}$, are non-degenerate. We say h is **monotone** if it is increasing in the I -direction.

We choose non-decreasing functions $l_i : \mathbb{R} \rightarrow [s_i, s_{i+1}]$ which are equal to s_i , and s_{i+1} near $-\infty$, and $+\infty$, respectively, for every i . After choosing almost complex structures this lets us write down a moduli problem for $u : \bigsqcup_{i=0}^k \mathbb{R} \times S^1 \rightarrow M$, where the equation corresponding to the i th component is the continuation map equation with Hamiltonian term given by $H_{l_i(s)}$. Therefore, a homotopy of Hamiltonians with stations (plus extra auxiliary choices) define a map $CF(H|_0) \rightarrow CF(H|_1)$ by com-

posing $CF(H|_0) \rightarrow CF(H|_{s_1}) \dots \rightarrow CF(H|_{s_k}) \rightarrow CF(H|_1)$. If the homotopy is monotone, the map is defined over $\Lambda_{\geq 0}$.

In the following, by a face of a simplex $\Delta^n = \{(x_1, \dots, x_{n+1} \mid x_i \geq 0, x_1 + \dots + x_{n+1} = 1\} \subset \mathbb{R}^{n+1}$ we mean any of its subsets that can be obtained by setting a subset (possibly empty) of the coordinates to 0. A function on a closed subset of Δ_n being smooth means that it can be extended to a smooth function on a neighborhood of it inside \mathbb{R}^{n+1} .

Definition 6. *We define an n -simplex family of homotopy of Hamiltonians with stations between H_0 and H_1 as a smooth map $H : \Delta^n \times I \times M \times S^1 \rightarrow \mathbb{R}$ such that $\{a\} \times \{0\} \times M \times S^1 \rightarrow \mathbb{R}$ is H_0 for all $a \in \Delta^n$, and $\{a\} \times \{1\} \times M \times S^1 \rightarrow \mathbb{R}$ is H_1 for all $a \in \Delta^n$. Moreover, we are given a subset $S \subset \Delta \times I$ (the stations) satisfying the conditions:*

- *There exists numbers $0 < s_1 \leq \dots \leq s_k < 1$ and faces F_1, \dots, F_k of Δ_n such that $S = \bigcup_{i=1}^k F_i \times \{s_i\}$.*
- *There exists a neighborhood U of $S \cup \Delta \times \{0\} \cup \Delta \times \{1\}$ such that for every $x \in M$ and $t \in S^1$, $H|_{U \times \{x\} \times \{t\}}$ is locally constant.*

*We say such family is **monotone** if it is increasing in the I -direction.*

Remark 3.2.2. *Note that there is a cosmetic difference between a 0-simplex family of homotopy of Hamiltonians and a homotopy of Hamiltonians (as in the first definition of this subsection, which we gave as a warm-up) related to how we choose to turn the data into a form that lets us write down the corresponding Floer equation (the next paragraph versus the paragraph right after Definition 5). Definition 6 is the one we use in practice.*

Let us denote the coordinate in the I -direction by r . Given $n > 0$ integer and an S as above, we fix a function $g_{n,S} : \Delta_n \times I \rightarrow M$ such that:

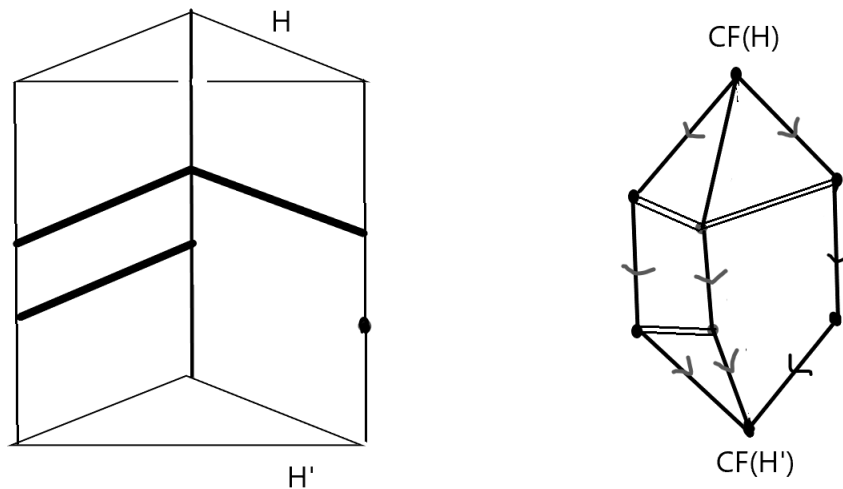

Figure 3-3: A family of Hamiltonians with stations as on the left gives rise to a diagram as on the right. Note that in the right picture there is a face in the back, and by a double edge we mean the identity map. Moreover, all faces carry homotopies, in particular the maximal dimensional face. We omit writing down the equations.

- $g_{n,S} \geq 0$,
- $g_{n,S}$ vanishes precisely along S ,
- all the integral curves of the vector field $g\partial_r$ are defined for all times $(-\infty, \infty)$.

We also want these functions to be compatible in the sense that if F is a face of Δ_n , $g_{n,S} \big|_F = g_{n-1,S \cap F}$. It is possible to make such choices (see the proof of Lemma 3.2.4).

Families of homotopies of Hamiltonians are then used to define homotopy coherent diagrams of maps from $CF(H|_0)$ to $CF(H|_1)$, which are defined over $\Lambda_{\geq 0}$, if the family is monotone. This follows from the gluing results of [29]. See Figure 3-3 for an example.

Remark 3.2.3. *Succintly, we defined an $(\infty, 1)$ category where the objects are non-degenerate Hamiltonians, and the Hom sets are Kan complexes given by the simplex*

families as above. In the monotone version, Hom sets are the monotone simplex families (which might be empty of course). The following lemma says that the non-empty Hom sets are contractible in either case. Floer theory constructs an ∞ -functor from these categories to the ∞ category of chain complexes (over $\Lambda_{\geq 0}$ in the monotone case).

A family of homotopy of Hamiltonians with stations on the boundary of Δ_n is a Δ_{n-1} -family of homotopy of Hamiltonians with stations defined on each $n - 1$ dimensional face of Δ_{n-1} so that the Hamiltonians glue together to a continuous function $\partial\Delta^n \times I \times M \times S^1 \rightarrow \mathbb{R}$ (we also have stations but no conditions on them). Note that this implies that $\partial\Delta^n \times I \times M \times S^1 \rightarrow \mathbb{R}$ is in fact smooth (this is not hard, see Lemma 16.8 of [23] for example).

Lemma 3.2.4. *Any family of homotopy of Hamiltonians with stations that is defined on the boundary of a simplex can be extended to the interior of the simplex. Crucially, if the initial family is monotone, the extension can be made monotone.*

Proof. First we note that we do not add more stations, so the new S is simply the union of old ones considered as a subset of Δ_n .

This is an application of Whitney Extension theorem [40], more accurately of the construction that is involved in proving it. We refer to Subsections VI.2.2 and VI.2.3 in [35] for the construction (i.e. Equation (8) in [35]) and its properties. The only property that the construction does not immediately satisfy is constancy near the stations. This is easy to fix. Let us call the extension so far \tilde{F} . We first define a function C in a neighborhood N of S via extending by constants. Then, we take a positive partitions of unity $f_1 + f_2 = 1$, where f_1 is supported inside N , and is equal to 1 in a neighborhood of S . We then define our final extension to be $F = f_1\tilde{F} + f_2C$. \square

The upshot of this discussion informally is that any partial homotopy coherent diagram of maps $CF(H)$ to $CF(H')$ can be filled, even over $\Lambda_{\geq 0}$. Instead of trying

explain this more rigourously, we give an example.

Example. Assume that we have Hamiltonians defined on the boundary of the $Cube_3$, which are also increasing along the vector field that we use to define monotonicity. This almost defines a 3-cube of chain complexes over $\Lambda_{\geq 0}$ except that we do not yet have the map associated to the top dimensional face. Note that what we are given can be repackaged as a family of homotopies of Hamiltonians with stations that is defined on the boundary of a hexagon. We can now triangulate our hexagon and fill in the inside (we could directly fill the hexagon too, but we say it in this way to be consistent with the general framework). Floer theory then gives us the desired map to complete our initial diagram to a 3-cube.

3.3 Construction of the invariant

3.3.1 Cofinality

Let X be a closed smooth manifold, and $A \subset X$ be a compact subset. We define $C_{A \subset X}^\infty := \{H \in C^\infty(X, \mathbb{R}) \mid H|_K < 0\}$. Note that $C_{A \subset X}^\infty$ is a directed set, with the relation $H \geq H'$ if $H(x) \geq H'(x)$ for all $x \in X$.

Lemma 3.3.1. *Let $H_1 \leq H_2 \leq \dots$ be elements of $C_{A \subset X}^\infty$. They form a cofinal family if and only if $H_i(x) \rightarrow 0$, for $x \in A$, and $H_i(x) \rightarrow \infty$, for $x \in X - A$, as $i \rightarrow \infty$.*

Proof. The only if direction is trivial, we prove the if direction. Take any $f \in C_{A \subset X}^\infty$, we need to show that there exists an $i > 0$ such that $f \leq H_i$.

By compactness, there is a $j > 0$ such that $f < H_j$ on A . But, then there has to be a neighborhood U of A such that $f < H_j$ on U .

Again, by compactness, there is a $j' > 0$ such that $f < H_{j'}$ on $X - U$. Choosing, $i = \max(j, j')$ finishes the proof. \square

3.3.2 Definition and basic properties

Let M be a closed symplectic manifold, $K \subset M$ be a compact subset. We call the following data an acceleration data for K :

- $H_1 \leq H_2 \leq \dots$ a cofinal family in $C_{K \times S^1 \subset M \times S^1}^\infty$
- Monotone 1-cube of Hamiltonians $\{H_s\}_{s \in [i, i+1]}$, for all i .

Note that acceleration data gives one $\mathbb{R}_{\geq 0}$ family of Hamiltonians, which we will denote by H_s . From an acceleration data, we obtain a 1-ray of chain complexes over $\Lambda_{\geq 0}$: $\mathcal{C}(H_s) := CF(H_1) \rightarrow CF(H_2) \rightarrow \dots$

We define $SC_M(K, H_s) := \widehat{tel}(\mathcal{C}(H_s))$.

If H_s and H'_s are two acceleration data such that $H_n \geq H'_n$ for all $n \in \mathbb{N}$, we can produce a map of 1-rays $\mathcal{C}(H'_s) \rightarrow \mathcal{C}(H_s)$, by filling in the 2-cubes.

$$\begin{array}{ccccccc}
 CF(H'_1) & \longrightarrow & CF(H'_2) & \longrightarrow & CF(H'_3) & \longrightarrow & \dots \\
 \downarrow & \searrow & \downarrow & \searrow & \downarrow & \searrow & \\
 CF(H_1) & \longrightarrow & CF(H_2) & \longrightarrow & CF(H_3) & \longrightarrow & \dots
 \end{array} \tag{3.3.2.1}$$

This map is unique up to homotopy of maps of 1-rays by filling in the 3-slits. Therefore we get a canonical map:

$$H(SC_M(K, H'_s)) \rightarrow H(SC_M(K, H_s)). \tag{3.3.2.2}$$

Moreover, if we have $H_n \geq H'_n \geq H''_n$, the canonical triangle is commutative, this time by filling in the 3-triangles.

Recall that for a 1-ray, we had the notion of a compression morphism, which induced an isomorphism after applying $H(\widehat{tel}(\cdot))$. A priori this isomorphism is not induced by Floer theory, so we need to remedy that.

Let $\mathcal{C}(H_s)^n = CF(H_{n(1)}) \rightarrow CF(H_{n(2)}) \rightarrow \dots$ be subdiagram. We can also think of $H_{n(1)} < H_{n(2)} < \dots$ as part of another acceleration data H'_s .

Lemma 3.3.2. • *There is a canonical isomorphism $H(\widehat{tel}(\mathcal{C}(H_s)^n)) \rightarrow H(\widehat{tel}(\mathcal{C}(H'_s)))$*

• *The diagram commutes:*

$$\begin{array}{ccc} H(\widehat{tel}(\mathcal{C}(H_s))) & \longrightarrow & H(\widehat{tel}(\mathcal{C}(H_s)^n)) . \\ \downarrow & \nearrow & \\ H(\widehat{tel}(\mathcal{C}(H'_s))) & & \end{array} \quad (3.3.2.3)$$

Proof. These follow from the results of the Contractibility section. We omit the details. \square

Proposition 3.3.3. *The comparison maps (as defined before (3.3.2.2)) $H(SC_M(K, H'_s)) \rightarrow H(SC_M(K, H_s))$ are isomorphisms.*

Proof. We can find subsequences $n(i)$ and $m(i)$ of natural numbers such that $H'_i < H_i < H'_{n(i)} < H_{m(i)}$. We then get three 2-rays glued to each other.

$$\begin{array}{ccccccc} CF(H'_1) & \longrightarrow & CF(H'_2) & \longrightarrow & CF(H'_3) & \longrightarrow & \dots \\ \downarrow & \searrow & \downarrow & \searrow & \downarrow & \searrow & \\ CF(H'_1) & \longrightarrow & CF(H'_2) & \longrightarrow & CF(H'_3) & \longrightarrow & \dots \\ \downarrow & \searrow & \downarrow & \searrow & \downarrow & \searrow & \\ CF(H'_{n(1)}) & \longrightarrow & CF(H'_{n(2)}) & \longrightarrow & CF(H'_{n(3)}) & \longrightarrow & \dots \\ \downarrow & \searrow & \downarrow & \searrow & \downarrow & \searrow & \\ CF(H_{m(1)}) & \longrightarrow & CF(H_{m(2)}) & \longrightarrow & CF(H_{m(3)}) & \longrightarrow & \dots \end{array} \quad (3.3.2.4)$$

Now we apply \widehat{tel} to this diagram. Using the discussion about compression maps, and contractibility we get that the composition of the first and last two maps become quasi-isomorphisms by Lemma 2.5.1. This implies the result. \square

- Proposition 3.3.4.** 1. Let H_s and H'_s be two different acceleration data, then $H(SC_M(K, H_s)) = H(SC_M(K, H'_s))$ canonically. Therefore we simply denote the invariant by $SH_M(K)$.
2. Let $\phi : M \rightarrow M$ be a symplectomorphism. There exists a canonical isomorphism $SH_M(K) = SH_M(\phi(K))$ by relabeling an acceleration data by ϕ .
3. For $K \subset K'$, there exists canonical restriction maps $SH_M(K') \rightarrow SH_M(K)$. This satisfies the presheaf property.

Proof. To construct the maps in the first part, we take acceleration data that dominates both cofinal sequence in question, and use the roof that it gives. The maps in 3, are defined exactly as the maps 3.3.2.2 were defined. The canonicity of maps in 1 and 3 are applications of contractibility. 2 is easy as we can relabel all choices by the symplectomorphism. \square

3.3.3 Computing $SH_M(M)$ and $SH_M(\emptyset)$

When $K = M$, take a C^2 -small non-degenerate H with no non-constant time-1 orbits, which is negative everywhere (see Lemma 5.3.1). We define $H_s = s^{-1}H$, for $s \geq 1$, as the acceleration data.

Let $CM(H)$ be the Morse complex of H with \mathbb{Z} -coefficients. On the other hand we denote by $CM(H, \Lambda_{\geq 0})$ the complex freely generated over $\Lambda_{\geq 0}$ by the critical points, but with the terms in the differential weighed by $T^{H(p+) - H(p-)}$.

By Pardon [29] Theorem 10.7.1, we see that the associated diagram for this acceleration data looks like

$$\dots CM(H_n, \Lambda_{\geq 0}) \rightarrow CM(H_{n+1}, \Lambda_{\geq 0}) \dots, \quad (3.3.3.1)$$

where a generator p in the n th level is sent to $T^{\frac{-H(p)}{n(n+1)}}p$ by the continuation map, using

$$\frac{1}{n(n+1)} = \frac{1}{n} - \frac{1}{n+1}.$$

It is easy to see that the direct limit of this diagram of chain complexes is $CM(H) \otimes_{\mathbb{Z}} \Lambda_{>0}$ with maps

$$CM(H_n, \Lambda_{\geq 0}) \rightarrow CM(H) \otimes_{\mathbb{Z}} \Lambda_{>0}, \quad (3.3.3.2)$$

sending p to $T^{-\frac{H(p)}{n}}p$. Completion does nothing to $CM(H) \otimes_{\mathbb{Z}} \Lambda_{>0}$. Using that $\Lambda_{>0}$ is flat, we get the result that was stated in the Introduction:

$$SH_M(M) = H(M, \mathbb{Z}) \otimes_{\mathbb{Z}} \Lambda_{>0}. \quad (3.3.3.3)$$

For $K = \emptyset$, we start with any non-degenerate H , and define $H_s = H + s$. The linear diagram for this acceleration data looks like $\dots C \rightarrow C \rightarrow \dots$ for some chain complex C , where all the maps are also the same. By the energy inequality, this map sends C to TC . Now looking at the definition of completed direct limit, we see that we are computing the inverse limit of 0-modules, which is also 0.

Remark 3.3.5. *We conjecture that the converse is also true, i.e. if K is non-empty, $SH_M(K) \neq 0$. Moreover, if K has an interior point, we expect that there is an $\epsilon > 0$ such that $T^\epsilon SH_M(K) \neq 0$.*

3.4 Multiple subsets

Let K_1, \dots, K_n be compact subsets of M . For every $I \subset [n]$, choose a cofinal sequence H_n^C for $C = \bigcap_{i \in I} K_i$, such that $H_n^C \geq H_n^{C'}$ whenever $C \subset C'$. Here I being the empty set means taking the union of K_i 's. For each n , fill the $(n+1)$ -cube, where the vertices are given by H_n^C and H_{n+1}^C , to a monotone n -cube family of Hamiltonians. Using Hamiltonian Floer theory, this gives us an $(n+1)$ -ray. The ordering of the coordinates of the slices is given by the ordering of the subsets. Here is a diagram for

how it looks like for $n = 2$ (K_1 and K_2 are denoted by X and Y):

$$\begin{array}{ccccccc}
& & & \cdots & \longrightarrow & CH(H_n^{X \cup Y}) & \longrightarrow & CH(H_{n+1}^{X \cup Y}) & \longrightarrow & \cdots \\
& & & & & \swarrow & & \searrow & & \\
& & & \cdots & \longrightarrow & CH(H_n^X) & \longrightarrow & CH(H_{n+1}^X) & \longrightarrow & \cdots \\
& & & & & \downarrow & & \downarrow & & \\
& & & \cdots & \cdots & \longrightarrow & CH(H_n^Y) & \cdots & \longrightarrow & CH(H_{n+1}^Y) & \longrightarrow & \cdots \\
& & & & & \swarrow & & \searrow & & \\
& & & \cdots & \longrightarrow & CH(H_n^{X \cap Y}) & \longrightarrow & CH(H_{n+1}^{X \cap Y}) & \longrightarrow & \cdots
\end{array}$$

Applying $\widehat{tel} \circ \widehat{cone}^n$ to this diagram, we construct a chain complex $SC_M(K_1, \dots, K_n)$.

Note that $SC_M(K_1, \dots, K_n)$ depends on the ordering of the subsets.

As commented on before, $SC_M(K_1, \dots, K_n)$ is a deformation of the chain complex

$$\bigoplus_{I \subset [n]} SC_M \left(\bigcap_{i \in I} K_i \right), \tag{3.4.0.1}$$

w.r.t the $|I|$ -filtration (i.e. the full differential is lower triangular, and the diagonal entries are the differentials from before). In this deformation the part of the differential that increases $|I|$ -filtration by 1 are given by restriction maps, the ones that increase by 2 are chain homotopies between compositions of restriction maps in different directions and so on.

The methods of the previous section with higher dimensional families of cubes, triangles, and slits etc. let us show that $SH_M(K_1, \dots, K_n) := H(SC_M(K_1, \dots, K_n))$ is well defined (again using Lemma 2.5.1). We omit more details.

Chapter 4

Properties of relative symplectic cohomology: proofs

In this chapter we finish the proofs of the remaining properties from Subsection 1.3. We repeat them for convenience

Theorem 4.0.1. *Relative symplectic cohomology satisfies the following properties.*

- *(Hamiltonian isotopy invariance of restriction maps) Let K, K' be compact subsets of M , and $\phi_t : M \rightarrow M$, $t \in [0, 1]$, be a Hamiltonian isotopy such that $\phi_t(K') \subset K$ for all t . We then have a commutative diagram*

$$\begin{array}{ccc} SH_M(K') & \longrightarrow & SH_M(\phi_1(K')) \\ & \searrow & \downarrow \text{relabeling} \\ & & SH_M(K) \end{array} \quad (4.0.0.1)$$

- *(displaceability condition) Let $K \subset M$ be displaceable by a Hamiltonian diffeomorphism, then $SH_M(K) \otimes_{\Lambda_{\geq 0}} \Lambda = 0$.*
- *(Kunneth formula) Let $K \subset M$ and $K' \subset M'$ be compact subsets, we have an explicitly defined module map $SH_M(K) \otimes_{\Lambda_{\geq 0}} SH_{M'}(K') \rightarrow SH_{M \times M'}(K \times K')$.*

See proof for a more precise statement.

4.1 Hamiltonian isotopy invariance of restriction maps

This is a natural generalization of the property with the same name in Floer-Hofer [12]. The Lemma below is the key part of the argument.

Lemma 4.1.1. *Let $H, H' : S_t^1 \times M \rightarrow \mathbb{R}$ be non-degenerate Hamiltonians and let $\phi_r, r \in [0, 1]$, with $\phi_0 = id$, be a Hamiltonian isotopy. Assume that $H' < H \circ \phi_r$ for all r . Then the diagram*

$$\begin{array}{ccc}
 CF(H') & \longrightarrow & CF(H) . \\
 \downarrow & \nearrow \text{relabeling} & \\
 CF(H \circ \phi_1) & &
 \end{array}
 \tag{4.1.0.1}$$

commutes up to homotopy defined over $\Lambda_{\geq 0}$.

Proof. Let us take monotone homotopies $H_{s,r}$ between H' and $H \circ \phi_r$ for all r depending smoothly on r and s . Let us also choose a function $\mathbb{R}_y \rightarrow I$ with $f((-\infty, 0]) = 0$ and $f([1, \infty)) = 1$.

Note that $u : \mathbb{R}_y \times S_t^1 \rightarrow M$ is a solution of the continuation map equation between H' and $H \circ \phi_r$ with perturbation term $X_{H_{f(y),r}}$ if and only if $\tilde{u} : (y, t) \mapsto \phi_{rf(y)}(u(y, t))$ is a solution of a slightly more generalized continuation map equation between H' and H (this is explained in Section 7a of [3]).

An important point is that the topological energies of u and \tilde{u} are the same by Stokes theorem, and the fact that ϕ_r is Hamiltonian.

We then construct the chain homotopy by counting accidental continuation map solutions between H' and $H \circ \phi_t$. By the observation above, this count is actually just a regular chain homotopy between two continuation maps in disguise, and it has all the properties we want. \square

Remark 4.1.2. *If the isotopy was symplectic, we could get a commutative triangle by modifying the relabeling map to take into account the fluxes of the generators along the isotopy. This has the drawback of not being defined over $\Lambda_{\geq 0}$, but it is definitely an important statement. On another note, we could also define a version with only the contractible orbits and then the same statement would be true for symplectic isotopies as well.*

We will prove that the composed maps $SH_M(K') \rightarrow SH_M(\phi_t(K)) \rightarrow SH_M(K)$ are constant in t by showing that they are constant in a neighborhood of each $t_0 \in [0, 1]$.

We can choose cofinal sequences H'_i for K' and H_i for $\phi_{t_0}(K)$ such that there exists a neighborhood $[t_0 - \epsilon, t_0 + \epsilon]$ where the inequality $H'_i < H_i \circ \phi_{t-t_0}$ is satisfied for every $t \in [t_0 - \epsilon, t_0 + \epsilon]$ and $i = 1, 2, \dots$. Fix such t , and choose extra data to construct the diagrams (with ϕ there being ϕ_{t-t_0}) as in the Lemma above for each i . We have to show that these diagrams are compatible with the continuation maps in the definition. Turn all of those homotopy coherent triangles into slits by the reparametrization trick in the proof. Choose monotone homotopies for H and H' and fill in the 3-dimensional diagram with homotopies. Now applying the reparametrization trick backwards finishes the proof.

4.2 Displaceability property

4.2.1 Changing the supports of Hamiltonians in the time interval

Let $H : M \times [0, 1] \rightarrow \mathbb{R}$, and $\rho : [0, 1] \rightarrow \mathbb{R}$ has integral 1. Define $H_\rho \stackrel{\heartsuit}{=} \rho \cdot H$. Clearly, the time-1 flows are the same $\phi_H^1 = \phi_{H_\rho}^1$. If we assume that ρ is compactly supported inside $(0, 1)$, we can extend H_ρ to a circle $S^1 := [0, 1] / \simeq$.

Let us start with a non-degenerate $H : M \times S^1 \rightarrow \mathbb{R}$, and choose a diffeo-

* typo:
$$H_\rho(t, x) = \int_0^t \rho(t') dt', x$$



morphism of $\phi : S^1 \rightarrow S^1$. We can then take $\rho := \phi' : S^1 \rightarrow \mathbb{R}$, and consider $H_\rho := \rho H : M \times S^1 \rightarrow \mathbb{R}$ as in the previous paragraph. The one-periodic orbits of H and H_ρ are in one-to-one correspondence. We would like to compare $CF(H, \Lambda_{\geq 0})$ and $CF(H_\rho, \Lambda_{\geq 0})$. Notice that, for any extra data necessary to define the differential in $CF(H, \Lambda_{\geq 0})$, one can cook up the extra data for $CF(H_\rho, \Lambda_{\geq 0})$ such that the moduli spaces defining differentials are naturally identified by reparametrizing the Floer solutions by the diffeomorphism $\phi \times id$ of $S^1 \times \mathbb{R}$. Such reparametrizations also do not change the topological energy. Hence, the obvious map $CF(H, \Lambda_{\geq 0}) \rightarrow CF(H_\rho, \Lambda_{\geq 0})$ given by identifying generators is in fact a quasi-isomorphism. Moreover, this map is compatible with continuation maps (for fixed ρ and varying H).

We need a slight generalization of this result, where we require ρ to be just non-negative, instead of positive. Here ρ cannot be integrated to a diffeomorphism, but we can still obtain the equivalence by a limiting argument. We consider the parametrized Floer moduli spaces for $H_{t\rho+(1-t)}$. By the argument in the previous paragraph these form a trivial fibration over $[0, 1)$. By the relevant Gromov compactness and gluing results, this shows that the natural one to one correspondence between Floer solutions for H and H_ρ extends to this case as well. All in all, we proved:

Lemma 4.2.1. *Let $\rho \geq 0$, and $H, H' : M \times S^1 \rightarrow \mathbb{R}$. Then the auxiliary choices can be made so that we have a commutative diagram:*

$$\begin{array}{ccc}
 CF(H, \Lambda_{\geq 0}) & \longrightarrow & CF(H_\rho, \Lambda_{\geq 0}) \\
 \downarrow & & \downarrow \\
 CF(H', \Lambda_{\geq 0}) & \longrightarrow & CF(H'_\rho, \Lambda_{\geq 0}),
 \end{array} \tag{4.2.1.1}$$

where the vertical arrows are continuation maps, and the horizontal ones are the reparametrization quasi-isomorphisms.

Remark 4.2.2. *This result also follows from Schwarz's version of Gromov trick from [31].*

4.2.2 Twisting relative symplectic cohomology by Hamiltonians

Using this construction, from $H_L, H_R : M \times [0, 1] \rightarrow \mathbb{R}$ we can cook up a new Hamiltonian $H_L \phi H_R : M \times S^1 \rightarrow \mathbb{R}$, such that the H_L and H_R parts are supported in $(1/2, 1)$ and $(0, 1/2)$ respectively (we fix the ρ 's in this construction once and for all). The Hamiltonian flow of $H_L \phi H_R$ is tangent to X_{H_R} first. After not moving for a short period, it arrives at $\phi_{H_R}^1$ in less than 1/2-time, and stops for a while. At some point after time 1/2, it starts moving again, this time being tangent to X_{H_L} , and reaches to $\phi_{H_L}^1 \circ \phi_{H_R}^1$ before time-1. It then stops for a little until time 1, after which repeats this flow.

Choose a cofinal family H_n for K and let $H : M \times I \rightarrow \mathbb{R}$ be a Hamiltonian. Let us choose the ρ 's in the previous paragraph to be non-negative. We can define $SH_M(K, H)$ via the family $H \phi H_n$ in the same way we defined $SH_M(K)$. Let us also define $SH_M(K, H, \Delta)$, for any real number Δ , using $H \phi H_n + \Delta$.

Basic properties of $SH_M(K, H)$ are summarized in the following proposition.

- Proposition 4.2.3.**
1. $SH_M(K, H)$ is independent of the choice of the acceleration data.
 2. $SH_M(K, 0) = SH_M(K)$
 3. For any $\Delta > \Delta'$, the natural map $SH_M(K, H, \Delta') \rightarrow SH_M(K, H, \Delta)$ is given by multiplication by $T^{\Delta - \Delta'}$.
 4. $SH_M(K, H) \otimes_{\Lambda_{\geq 0}} \Lambda = SH_M(K) \otimes_{\Lambda_{\geq 0}} \Lambda$

Proof. 1. Exactly the same proof with $SH_M(K)$.

2. This follows from Lemma 4.2.1

3. This follows from regularity.*

* not really, best fix: change 3. to $T^{\Delta - \Delta'}$ q-iso.

4. Let a be the maximum value of ρ . We get maps $SH_M(K, 0, a \cdot \min(H)) \rightarrow SH_M(K, H) \rightarrow SH_M(K, 0, a \cdot \max(H)) \rightarrow SH_M(K, H, a(\max(H) - \min(H)))$ from the standard setup. By contractibility, the composition of the first two and last two maps are simply multiplication by $T^{a(\max(H) - \min(H))}$, which becomes an isomorphism after tensoring with the fraction field.

□

4.2.3 Finishing the proof: dying generators

Let ϕ be a displacing Hamiltonian diffeomorphism for K , and let H be a generating Hamiltonian. Our goal is to prove the following statement, which finishes the proof by the previous proposition.

Proposition 4.2.4. $SH_M(K, H) = 0$

In fact, ϕ displaces a domain neighborhood D of K . Let $N = \partial D \times [-1, 1] \subset D$ be a normal neighborhood so that $\partial D = \partial D \times \{1\}$ and K lies strictly inside $D - \partial D \times [-1, 1]$. Let D' and D'' be the domains with the boundary $\partial D \times \{0\}$ and $\partial D \times \{-1\}$ respectively. Choose H_n 's to be so that ∂D and $\partial D'$ are level sets of H_0 , and that $H_n = H_0 + n$ on $M - D''$ for all n .

Let $H_s : S^1 \times M \rightarrow \mathbb{R}$, $s \in [n, n+1]$ be a monotone one parameter family of Hamiltonians between H_n and H_{n+1} satisfying $H_s = H_0 + s$ outside of D' . Fix a non-decreasing smooth function $\mathbb{R} \rightarrow I$ with $f((-\infty, 0]) = 0$ and $f([1, \infty)) = 1$.

We consider the one parameter family of continuation map equations $P_{c,n}$, $c \in [1, \infty)$, for $u : S^1 \times \mathbb{R} \rightarrow M$,

$$J \frac{\partial u}{\partial s} = \frac{\partial u}{\partial t} - X_{H \circ \phi_{H f(\frac{s}{c}) + n}}. \quad (4.2.3.1)$$

The following lemma is elementary but very useful.

Lemma 4.2.5. *Let V be any time dependent vector field on M^n equipped with a Riemannian metric g . For any $\gamma : [0, 1] \rightarrow M$, we have*

$$\int_{[0,1]} |\gamma'(t) - V_t(\gamma(t))|^2 > \tau \sup d(\gamma(t), \phi^t(\gamma(0)))^2 \quad (4.2.3.2)$$

where $\tau = \tau(g)$.

The following lemma is the key part of the argument.

Lemma 4.2.6. *There exists an $a > 0$ (independent of s/c) such that for any 1-periodic loop $\gamma : S^1 \rightarrow M$, if $\int_{S^1} |\gamma'(t) - X_{H\Phi H_{f(\frac{s}{c})+n}}(\gamma(t))|^2 < a$, then $\gamma([0, 1/2]) \subset M - D''$.*

Proof. Because ϕ displaces D , either $\gamma(0)$ or $\phi(\gamma(0))$ needs to lie outside of D . For sufficiently small a , the previous lemma and conservation of energy implies then that $\gamma(0)$ or $\gamma(1/2)$ needs to lie outside of D' . Again using the lemma and conservation of energy, this implies that, choosing a possibly smaller a , $\gamma([0, 1/2]) \subset M - D''$, as desired. \square

Proposition 4.2.7. *For sufficiently large c any solution of $P_{n,c}$ converging to periodic orbits has topological energy at least 0.1.*

Proof. Consider the energy identity (item 4. from Section 3.1):

$$\text{top}E(u) = \int_{S^1 \times \mathbb{R}} \left| \frac{\partial u}{\partial t} - X_{H\Phi H_{f(\frac{s}{c})+n}}(u(s, t)) \right|^2 ds dt + \int_{S^1 \times \mathbb{R}} (\partial_s H \Phi H_{f(\frac{s}{c})+n}) ds dt, \quad (4.2.3.3)$$

where u is a solution of $P_{n,c}$.

Now choosing a as in the previous lemma:

$$\text{top}E(u) \geq Ca + (c - C) \int_{[0,1/2]} \frac{\rho}{c} dt = Ca + \frac{c - C}{c}, \quad (4.2.3.4)$$

where C is the measure of $s_0 \in [0, c]$ with $\int_{S^1} |\frac{\partial u}{\partial t} - X_{H\phi H_{f(\frac{s_0}{c})+n}}(u(s_0, t))|^2 \geq a$. The result follows. \square

We can set up our linear diagrams using these slowed down monotone homotopies:

$$CF(H\phi H_0) \rightarrow CF(H\phi H_1) \rightarrow CF(H\phi H_2) \rightarrow \dots \quad (4.2.3.5)$$

Using the energy inequality and Proposition 4.2.7, we get that the image of $CF(H\phi H_n)$ lies inside $T^{0.1}CF(H\phi H_{n+1})$ for every n . Now using the definition of SH_M with the usual colimit, we get the result.

Remark 4.2.8. *Being slightly more careful in the proof, we can in fact prove that $T^{r_\phi}SH_M(K) = 0$, where r_ϕ is the Hofer norm of ϕ . This leads to an energy-capacity inequality: Let us define the capacity of a module A over $\Lambda_{\geq 0}$ to be $\inf \{r \mid T^r A = 0\}$. Denote the capacity of $SH_M(K)$ by $c_M(K)$. We then have $d_M(K) \geq c_M(K)$, where $d_M(K)$ is the displacement energy of K . Of course this would be only useful if we had a way of understanding $c_M(K)$. See Remark 3.3.5 as well.*

4.3 Kunneth formula

Given two functions $H : M \times S^1 \rightarrow \mathbb{R}$ and $F : N \times S^1 \rightarrow \mathbb{R}$, we obtain a function $F \oplus H : M \times N \times S^1 \rightarrow \mathbb{R}$. It is known that $CF(H, M) \otimes CF(F, N)$ can be canonically identified with $CF(H \oplus F, M \times N)$. The same statement is true for continuation maps.

Let $K \subset M$ and $P \subset N$ be compact subsets. Let $\mathcal{C} := C_0 \rightarrow C_1 \rightarrow C_2 \rightarrow \dots$ and $\mathcal{D} := D_0 \rightarrow D_1 \rightarrow D_2 \rightarrow \dots$ be any choice of linear diagrams used to define $SH_M(K) = H(\widehat{tel}(\mathcal{C}))$ and $SH_N(P) = H(\widehat{tel}(\mathcal{D}))$ respectively. Then we have that the diagram $\mathcal{C} \otimes \mathcal{D} := C_0 \otimes D_0 \rightarrow C_1 \otimes D_1 \rightarrow C_2 \otimes D_2 \rightarrow \dots$ computes $SH_{M \times N}(K \times P) = H(\widehat{tel}(\mathcal{C} \otimes \mathcal{D}))$.

The homology level statement is weak but we go through it. We have the following

chain of canonical maps:

$$SH_M(K) \otimes SH_N(P) = H(\widehat{tel}(\mathcal{C})) \otimes H(\widehat{tel}(\mathcal{D})) \rightarrow H(\widehat{tel}(\mathcal{C})) \otimes \widehat{tel}(\mathcal{D}) \rightarrow \quad (4.3.0.1)$$

$$\rightarrow H(\widehat{tel}(\mathcal{C}) \widehat{\otimes} \widehat{tel}(\mathcal{D})) \rightarrow H(\widehat{tel}(\mathcal{C} \otimes \mathcal{D})) = SH_{M \times N}(K \times P) \quad (4.3.0.2)$$

The last arrow requires explanation. We have a quasi-isomorphism $tel(\mathcal{C} \otimes \mathcal{D}) \rightarrow \mathit{hocolim}(\mathcal{C} \boxtimes \mathcal{D}) = tel(\mathcal{C}) \otimes tel(\mathcal{D})$, using some theory of homotopy colimits that we do not go into [8]. This stays a quasi-isomorphism after completing it (Lemma 2.4.3), and then we take the inverse of the induced map on homology. In particular the last arrow is an isomorphism.

The first two arrows are generally not isomorphisms because tensor product does not commute with homology (algebraic Kunnetth formula) or completion (completed tensor product).

Remark 4.3.1. *We now briefly discuss a place where these ideas might be useful. Let S be any simple loop in T^2 with some area form. It is easy to compute that $SH_{T^2}(S) = \widehat{\bigoplus}_{n \in \mathbb{Z}} \Lambda_{\geq 0} x^n$. Moreover, if $\mathcal{C} := C_0 \rightarrow C_1 \rightarrow C_2 \rightarrow \dots$ is a linear diagram for $K \subset M$, then $SH_{M \times T^2}(K \times S) = H(\widehat{\bigoplus}_{n \in \mathbb{Z}} \widehat{tel}(\mathcal{C}))$. In particular, we have an injective map $SH_M(K) \rightarrow SH_{M \times T^2}(K \times S)$.*

We know that if K is displaceable $SH_M(K)$ is torsion, but the above discussion shows that stable displaceability (i.e. $S \times K \subset T^2 \times M$ is displaceable) is enough. In particular, by the Mayer-Vietoris property (the simple version with non-intersecting boundaries) we obtain that the restriction map

$$SH_M(M) \otimes \Lambda \rightarrow SH_M(M - K) \otimes \Lambda \quad (4.3.0.3)$$

is an isomorphism.

This is important because for example any symplectic submanifold is stably displaceable, by the h -principle described in [9]. McLean [25], from whom we learned

this link, extends the displacibility result to more singular subsets, and also proves the isomorphism independently. We stress that the proof of his main theorem regarding quantum cohomology and birational equivalences involves a lot more work on top of what we have mentioned here.

Remark 4.3.2. *We note that Groman's reduced symplectic cohomology admits a much cleaner Kunnetth formula.*

Chapter 5

Mayer Vietoris property

5.1 An algebraic result

The following proposition is what we need from Chapter 2. The proof of it is a combination of the results in that chapter, culminating in the last two lemmas in Section 2.5. The precise definition of an n -ray is given in Subsection 2.2.6.

Proposition 5.1.1. *Let $\mathcal{C} = \mathcal{C}_1 \rightarrow \mathcal{C}_2 \rightarrow \dots$ be a $\mathbb{Z}/2$ -graded 3-ray over $\Lambda_{\geq 0}$. Let $\mathcal{D}^{ij} = D_1^{ij} \rightarrow D_2^{ij} \rightarrow \dots$, $i, j \in \{0, 1\}$ be the 1-rays that are the infinite edges of \mathcal{C} . This means that we have a homotopy coherent diagram of chain complexes which looks like (arrows depict all maps and homotopies):*

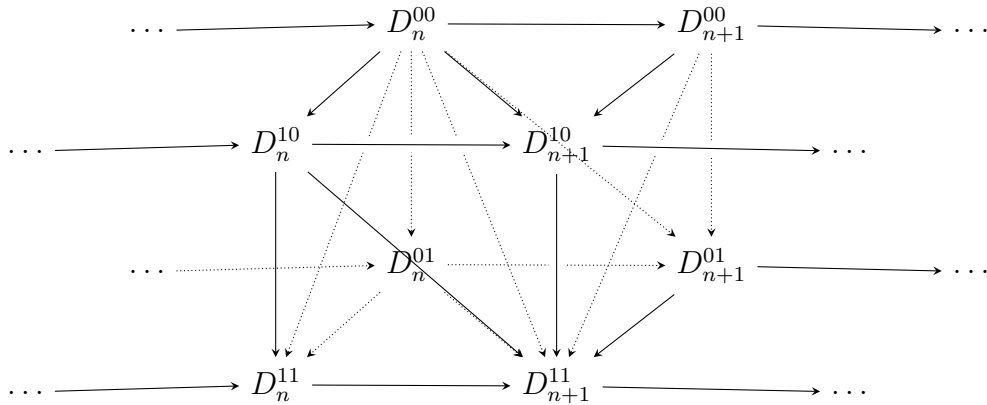

Hence for every n , \mathcal{C}_n is equal to the 2-cube (where we also gave names to the maps):

$$\begin{array}{ccc}
 D_n^{00} & \xrightarrow{f_n^{10}} & D_n^{10} \\
 f_n^{01} \downarrow & \searrow h_n & \downarrow g_n^{01} \\
 D_n^{01} & \xrightarrow{g_n^{10}} & D_n^{11},
 \end{array} \tag{5.1.0.1}$$

and $\text{cone}^{\circ 2}(\mathcal{C}_n)$ is the chain complex $D_n^{00} \oplus (D_n^{10}[1] \oplus D_n^{01}[1]) \oplus D_n^{11}$ with differential d_n :

$$\begin{pmatrix}
 d_n^{00} & 0 & 0 & 0 \\
 -f_n^{10} & -d_n^{01} & 0 & 0 \\
 f_n^{01} & 0 & -d_n^{10} & 0 \\
 h_n & g_n^{01} & g_n^{10} & d_n^{00}
 \end{pmatrix}. \tag{5.1.0.2}$$

Assume that

1. D_n^{ij} is free and finitely generated for all $n \in \mathbb{N}$ and $i, j \in \{0, 1\}$.
2. $\text{cone}^{\circ 2}(\mathcal{C}_n) \otimes_{\Lambda_{\geq 0}} \Lambda_{\geq 0}/\Lambda_{> 0}$ is acyclic for all n . Note that if we equip D_n^{ij} 's with bases, $\text{cone}^{\circ 2}(\mathcal{C}_n) \otimes_{\Lambda_{\geq 0}} \Lambda_{\geq 0}/\Lambda_{> 0}$ is simply the chain complex over \mathbb{Q} with the differential that is obtained by setting $T = 0$ in the matrix of d_n .

Then there is an exact sequence,

$$\begin{array}{ccc}
 H(\widehat{\text{tel}}(\mathcal{D}^{00})) & \longrightarrow & H(\widehat{\text{tel}}(\mathcal{D}^{10})) \oplus H(\widehat{\text{tel}}(\mathcal{D}^{01})). \\
 \uparrow [1] & \swarrow & \\
 H(\widehat{\text{tel}}(\mathcal{D}^{11})) & &
 \end{array} \tag{5.1.0.3}$$

where the degree preserving arrows are induced from \mathcal{C}

5.2 Zero energy solutions

Let $X, Y \subset M$ be two compact subsets. In the cases that we prove the existence of a Mayer-Vietoris sequence, we use the following approach.

We can choose acceleration data H_s^A , for $A = X \cap Y, X, Y, X \cup Y$, so that $H_n^A \geq H_n^B$, whenever $A \subset B$. We can then construct a 3-ray with $\mathcal{C}(H_s^A)$ at the four infinite edges:

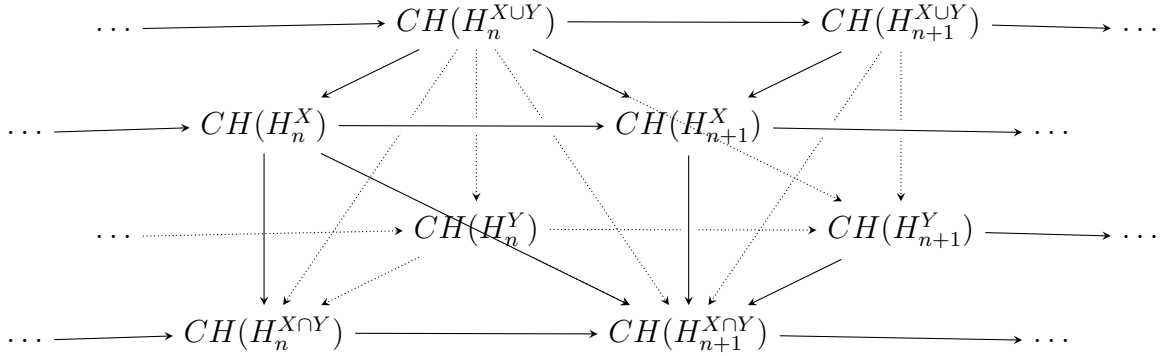

The 2-cube slices of this 3-ray look like:

$$\begin{array}{ccc}
 CH(H_n^{X \cup Y}) & \longrightarrow & CH(H_n^X) \quad . \\
 \downarrow & \searrow & \downarrow \\
 CH(H_n^Y) & \longrightarrow & CH(H_n^{X \cap Y})
 \end{array} \tag{5.2.0.1}$$

We want to show that the acceleration data can in fact be chosen so that the assumptions of Proposition 5.1.1 are satisfied. The first one is automatic. For the second one the following simple observation is crucial.

Let $h_0 \leq h_1$ be non-degenerate Hamiltonians with a monotone homotopy h_s between them. Let γ_0 and γ_1 be one-periodic orbits of h_0 and h_1 respectively. We make more choices and define the continuation map $con : CF(h_0) \rightarrow CF(h_1)$. We consider the matrix coefficient $\alpha := \langle con(\gamma_0), \gamma_1 \rangle \in \Lambda_{\geq 0}$.

Lemma 5.2.1. • *If $val(\alpha) = 0$, then $\gamma_0 = \gamma_1$, and $h_s \circ \gamma_0 : S^1 \rightarrow \mathbb{R}$ is independent of s .*

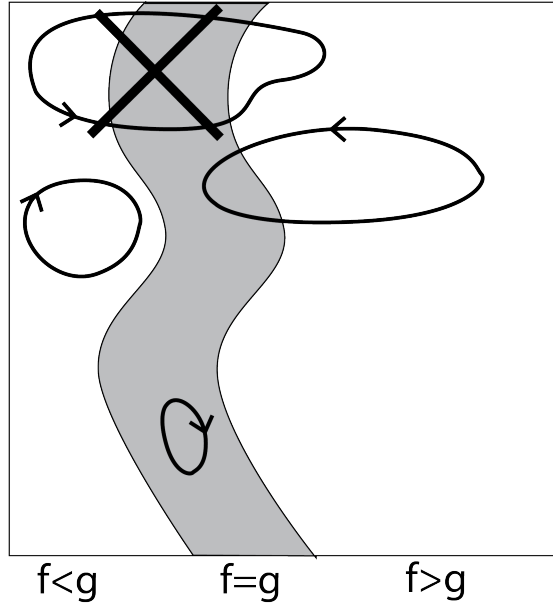

Figure 5-1: A cartoon of the situation in Proposition 5.2.2. The crossed orbit is not allowed. The other 3 orbits each belong to one of the 3 groups described in the proof.

- Assume that h_s is C^∞ -wise constant along γ_0 . Then γ_0 is a non-degenerate one-periodic orbit for h_1 , and if we take γ_1 to be that, $val(\alpha) = 0$.

Proof. The first statement immediately follows from the energy identity (Equation (3.2.0.6) in Subsection 3.2). For the second statement, note that $u(s, t) = \gamma_0(t)$ satisfies the Floer equation. This solution is regular. By the energy identity, it is the only solution with zero topological energy. Moreover, it is easy to see that the compactified moduli space of (possibly bubbled and broken) stable Floer trajectories in the homotopy class of the constant solution also consists only of this solution. This proves the statement by Lemma 5.2.6 of [29]. \square

Let f and g be two non-degenerate Hamiltonians. We define $U = \{f < g\} \subset M \times S^1$ and $V = \{f > g\} \subset M \times S^1$. The graph of $\gamma : S^1 \rightarrow M$ is the image of the map $\gamma \times id : S^1 \rightarrow M \times S^1$.

Proposition 5.2.2. *Assume that \bar{U} and \bar{V} are disjoint. Then, $\max(f, g)$ and $\min(f, g)$ are smooth functions.*

Moreover, assume that no one-periodic orbit of X_f , X_g , $X_{\min(f, g)}$ or $X_{\max(f, g)}$ has a graph that intersects both U and V (see Figure 5-1). Then, $\max(f, g)$ and $\min(f, g)$ are non-degenerate, and,

$$\begin{array}{ccc}
 CF(\min(f, g)) & \longrightarrow & CF(f) \\
 \downarrow & \searrow & \downarrow \\
 CF(g) & \longrightarrow & CF(\max(f, g))
 \end{array} \quad . \quad (5.2.0.2)$$

is acyclic, for any choice of monotone 2-cube family of Hamiltonians and extra data necessary to define the maps.

Proof. Note that if $h = h'$ on an open set S , and h_s is a monotone homotopy from h to h' , then $h_s = h$ on \bar{S} with all derivatives.

The first statement is elementary. Non-degeneracy of $\max(f, g)$ and $\min(f, g)$ follow from the fact that their one periodic orbits all occur also as orbits of X_f or X_g with the same return map, by our assumption.

The one periodic orbits of the 4 Hamiltonians in question fall under 3 groups: the ones whose graph

1. intersects U
2. intersects V
3. lies in $M \times S^1 - (U \cup V) = \{f = g\}$

The group 3 is common to all of them. 1 of f is the 1 of $\min(f, g)$; 2 of f is the 2 of $\max(f, g)$; 1 of g is the 1 of $\max(f, g)$ and 2 of g is the 1 of $\min(f, g)$.

Now set $T = 0$ and use the previous lemma. The only thing left to note is that the homotopy map is necessarily zero (after $T = 0$). This is because the family of

topological energy zero solutions have virtual dimension 1 and hence the corresponding virtual count is 0. One can also use the mod 2 grading to reach to the same conclusion since homotopy map is supposed to have degree 1. \square

Remark 5.2.3. *In the applications below U and V will be of the form $\tilde{U} \times S^1$ and $\tilde{V} \times S^1$. Note that in that case, the condition of not intersecting both U and V is empty for constant orbits.*

5.3 Boundary accelerators

In this section we explain how to choose an acceleration data so that the interesting Hamiltonian dynamics concentrates near hypersurfaces that tightly envelop the compact subset in question.

Definition 7. *Let K be a subset, we say that a sequence of compact domains D_K^1, D_K^2, \dots approximate K if*

- $\bigcap D_K^i = K$
- $D_K^{i+1} \subset \text{int}(D_K^i)$

Note that every compact subset can be approximated by compact domains.

Definition 8. *A **boundary accelerator** consists of three pieces of data:*

1. *A strictly increasing sequence of positive numbers Δ_i which converge to infinity as $i \rightarrow \infty$.*
2. *A sequence of triplets of compact domains $\{(fill(\partial N_K^{i-}), N_K^i, fill(\partial N_K^{i+}))\}_{i \in \mathbb{Z}_{>0}}$ such that*
 - $fill(\partial N_K^{i-}) \cup N_K^i \cup fill(\partial N_K^{i+}) = M$.
 - *The interiors of $fill(\partial N_K^{i-}), N_K^i, fill(\partial N_K^{i+})$ are pairwise disjoint*

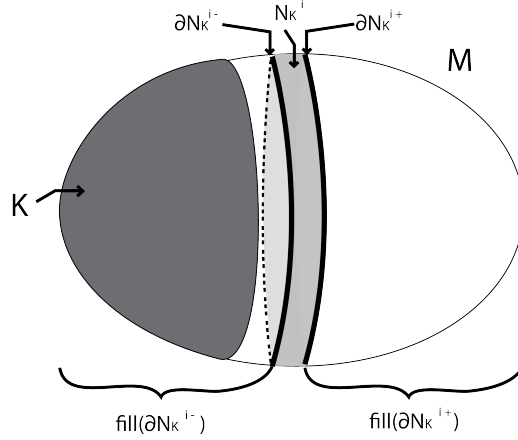

Figure 5-2: One mixing region in a boundary accelerator, and the relevant notation.

- $\partial N_K^i = \partial N_K^{i-} \sqcup \partial N_K^{i+}$, $\partial \text{fill}(\partial N_K^{i-}) = \partial N_K^{i-}$, $\text{fill}(\partial N_K^{i+}) = \partial N_K^{i+}$.
- $\text{fill}(\partial N_K^{i-})$ approximate K .
- N_K^i is contained in the interior of $\text{fill}(\partial N_K^{(i+1)+})$.

We call N_K^i the **mixing regions**, $\text{fill}(\partial N_K^{i-})$ the **inner fillers**, and $\text{fill}(\partial N_K^{i+})$ the **outer fillers**.

3. Smooth functions $f_i : N_K^i \rightarrow [0, \Delta_i]$ such that

- f_i has no critical points along ∂N_K^i .
- $f_i^{-1}(0) = \partial N_K^{i-}$ and $f_i^{-1}(\Delta_i) = \partial N_K^{i+}$.

We call these the **excitation functions**.

See Figure 5-2 for a cartoon depicting the situation. We will generally drop the fillers from notation, but they are always there.

Now we explain how we get a valid acceleration data starting from a boundary accelerator. An extra property we want is to restrict the points that a non-constant periodic orbit can pass through to the mixing regions. The following lemma is our main tool in that respect.

Lemma 5.3.1. *Let $H : X \rightarrow \mathbb{R}$ be a smooth function, where X is a manifold with boundary and H is constant along the boundary. For small enough $\epsilon > 0$, all time-1 orbits of $X_{\epsilon H}$ are constant.*

Proof. This follows from the more general theorem of Yorke [41]. □

Moreover, we will need to perturb the excitation functions to have non-degenerate orbits, but we will have to perturb in a very controlled fashion. We start with a preparatory lemma.

Lemma 5.3.2. *Let $F : M \times [0, 1] \rightarrow \mathbb{R}$ be a Hamiltonian, and $\gamma : [0, 1] \rightarrow M$ a flow line of X_{F_t} . Then, for any $t_0 \in (0, 1)$, neighborhood V of $\gamma(t_0)$ in M , real number $\delta > 0$, and positive integer n ; we have that for every $v \in T_{\gamma(1)}M$, there is a smooth one parameter family of functions $f_s : M \times [0, 1] \rightarrow \mathbb{R}$, $s \in [0, \tau)$, for some $\tau > 0$, such that*

- $f_0 = 0$
- for some $\epsilon > 0$, $f_s(x, t) = 0$, for $t < \epsilon$ and $t > 1 - \epsilon$ and all s
- $f_s \geq 0$, for all s
- $|f_s|_{C^n} < \delta$, for all s
- $\text{supp}(f) \subset V \times [0, 1]$
- The tangent vector to the curve $s \mapsto \phi_{F+f_s}^1(\gamma(0))$ at $s = 0$ is in the direction of v .

Proof. We can easily reduce to the case $\gamma([0, t_0]) \subset V$. Moreover, because X_{F_t} induces a one parameter family of diffeomorphisms, we can in fact assume that the entirety of γ is contained in V . Using the formula for the Hamiltonian function inducing the composition of two Hamiltonian functions, we can moreover assume that γ is a constant orbit, and the flow of X_{F_t} is identity in a neighborhood of it.

Finally, using sufficiently C^n -small positive cutoffs, we can assume that $V = M = \mathbb{C}^n$ and $F_t = 0$ everywhere, but with a smaller δ for the C^n -bound. Consider the linear function $-Jv \cdot x + c$, which is positive in a neighborhood of the origin. By changing its support in the time domain as in Subsection 4.2.1 we can make it supported away from 0 and 1 keeping it positive. Call the resulting Hamiltonian f and define $f_s = sf$, which does the job for sufficiently small s .

□

Lemma 5.3.3. *Let $H : M \times S^1 \rightarrow \mathbb{R}$ be a Hamiltonian, and n be a positive integer.*

Let $U \subset M$ be an open subset, then there exists a $H' : M \times S^1 \rightarrow \mathbb{R}$ such that

- $\text{supp}(H - H') \subset U \times S^1$
- H' is arbitrarily C^n -close to H in all compact subsets of U
- $H \geq H'$ (or the other way)
- All one-periodic orbits of $X_{H'}$ which intersect U are non-degenerate.

Proof. Given the previous lemma, this is a standard transversality argument. Let f be any strictly positive smooth function on U . Consider the space \mathcal{F} of all functions $M \times S^1 \rightarrow \mathbb{R}$ satisfying:

- $\text{supp}(H - H') \subset U \times S^1$
- $|H' - H|_{C^n} < f$ along U
- $H \geq H'$ (or the other way)

All we need to show is that the map $\mathcal{F} \times M \rightarrow M \times M$ given by $(h, x) \mapsto (x, \phi_h^1(x))$ is transverse to the diagonal. This follows from the previous lemma. \square

Whenever we say we make perturbations, or apply perturbation lemma, we will mean that we are using this lemma. If we want to stress that we are using the third bullet point, we will say that we are making **monotone perturbations**.

Proposition 5.3.4. *Let K be a compact subset of a closed symplectic manifold M , then we can find functions $h_i : M \rightarrow \mathbb{R}$ such that*

- *There exists mixing regions N_K^i (with fillers) and a sequence of numbers Δ_i so that $(h_i |_{N_K^i}, N_K^i, \Delta_i)$ is a boundary accelerator.*
- *The critical points of h_i inside the fillers are non-degenerate as time-1 orbits of X_{h_i}*
- *All non-constant one-periodic orbits of X_{h_i} are contained outside of a neighborhood of the fillers of N_K^i .*
- *There exists a sequence of positive numbers $\delta_i \rightarrow 0$ such that $\delta_i < h_i |_{fill(\partial N_K^{i-})} \leq 0$, with equality only the boundary, and for $x \in fill(\partial N_K^{i-})$, $h_{i-1}(x) \leq h_i(x)$.*
- *$\Delta_i \leq h_i |_{fill(\partial N_K^{i+})} < \Delta_{i+1}$, with equality only on the boundary.*

Proof. Using compactness, we first find approximating domains for K . Then using tubular neighborhood theorem, we construct boundary accelerators. Lastly, we extend the excitation functions to the fillers step by step.

1. We extend the excitation functions to the fillers so that the extension is negative in the interior of the inner filler, and it is bigger than Δ_i in the interior of the outer filler.

2. By making compactly supported perturbations in the interior of the fillers we can make the functions Morse on the fillers. Note that our perturbation theorem does not apply to this situation as we used time dependent Hamiltonians there. Nevertheless, this is standard, and we omit more details

3. Momentarily denote the function restricted to a small neighborhood of the inner filler by f . Let $\tilde{w} : [0, \Delta_i] \rightarrow [\epsilon, 1]$ be a non-decreasing function which is equal to ϵ in a neighborhood of 0, and to 1 in a neighborhood of Δ_i . We then extend $\tilde{w} \circ h_i$ to a function w on M by constants. If we multiply the function we had constructed in (2) by w , it still satisfies all the previous properties, but now $f \rightarrow \epsilon f$. By choosing ϵ small enough we can make sure that there are no non-constant orbits contained in a neighborhood of the inner filler. We do the same for the outer filler, but this time we have to think of Δ_i as the zero level, and hence the rescaling results in $f \mapsto \Delta_i + \epsilon(f - \Delta_i)$. Finally notice that choosing ϵ small enough also achieves the extra non-degeneracy condition on the Morse critical points inside the fillers, as well as the last two conditions from the statement of the proposition.

□

Proposition 5.3.5. *Let h_i be as in Proposition 5.3.4. We also fix $n > 0$ an integer, and $\tau > 0$ a real number.*

We can find $H_i : M \times S^1 \rightarrow \mathbb{R}$ such that

- $H_i = h_i$ on the fillers.
- $H_i(\text{int}(N_K^i)) \subset (0, \Delta_i)$.
- $|H_i - h_i|_{C^n} < \tau$.
- All one-periodic orbits of X_{H_i} are non-degenerate.

In particular, H_i 's form a non-degenerate cofinal sequence for K .

Proof. We apply the perturbation lemma with U being the interior of N_K^i 's. \square

See Figure 5-3 for a summary of this procedure that constructs a cofinal sequence (and by linear interpolation acceleration data) from boundary accelerators.

Remark 5.3.6. *The main gain from this careful construction was that we achieved our goals while changing the excitation functions only in very controlled ways from what they were originally. In the remaining sections, we will have to go through this construction again, trying to do it for two subsets simultaneously, while satisfying certain extra conditions related to Proposition 5.2.2. Roughly speaking, the excitation functions will satisfy these extra conditions by the assumptions, and our goal will be to not ruin this.*

5.4 Non-intersecting boundaries

In this section we investigate the case when X and Y are two compact domains with disjoint boundaries.

Definition 9. *We say that boundary accelerators $(f_i^X, N_X^i, \Delta_i^X)$ and $(f_i^Y, N_Y^i, \Delta_i^Y)$ are **compatible** if*

- N_X^i and N_Y^i are disjoint
- $\Delta_i^X = \Delta_i^Y$

Proposition 5.4.1. *We can find h_i^X and h_i^Y as in Proposition 5.3.4 such that*

- *The corresponding boundary accelerators are compatible*

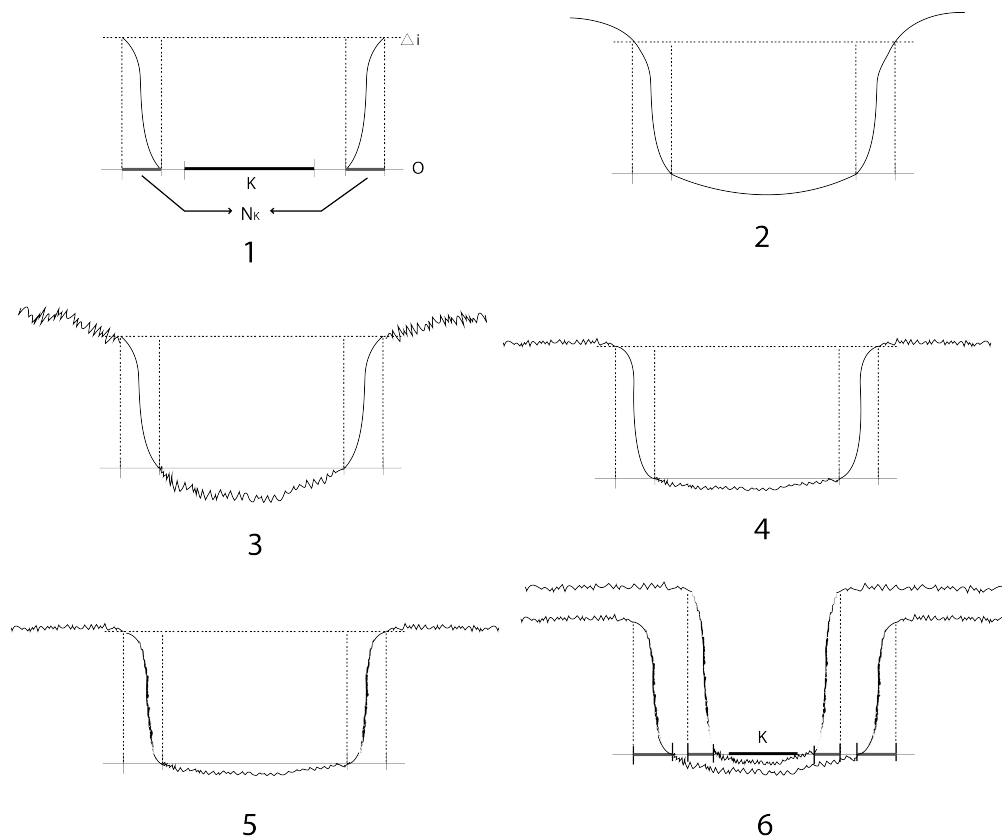

Figure 5-3: This is a summary of the construction of a cofinal sequence for K via boundary accelerators. 1) Boundary accelerators, 2) Extending excitation functions to smooth functions on the entire manifold, 3) Morsifying inside the fillers without changing the function along the mixing regions, 4) Scaling the functions in a neighborhood of the fillers, so that the non-constant one-periodic orbits are forced to lie inside the mixing region, 5) Making the non-constant orbits non-degenerate (note that in reality we start using time dependent Hamiltonians at this step), 6) Two Hamiltonians constructed in this way for K to illustrate how the cofinal family looks.

- $h_i^X = h_i^Y$ is satisfied in a compact domain.
- $\min(h_i^X, h_i^Y) \leq \min(h_{i+1}^X, h_{i+1}^Y)$ on $\text{fill}(N_X^{(i+1)-}) \cap \text{fill}(N_Y^{(i+1)-})$.

Proof. We start with any pair of compatible boundary accelerators. We extend the excitation functions to smooth functions as in Step (1) of the proof of Proposition 5.3.4 so that the extensions are the same along a compact domain D . We now want to perturb these to achieve Morseness (Step (2)). First, we make some common perturbation inside D . And then we take a smaller compact domain and separately apply monotone perturbations outside of it. We repeat this for outer fillers. All the perturbations are compactly supported and are away from the mixing regions of the boundary accelerators. Finally we make the functions very flat (Step (3)) compatibly. \square

As the final step, we independently apply the perturbation lemma to obtain H_i^X and H_i^Y , again using that the mixing regions are disjoint.

- Proposition 5.4.2.** 1. $\min(H_i^X, H_i^Y)$ form a non-degenerate cofinal family for $X \cup Y$. Similarly with \max for the intersection.
2. These functions can be filled into a 3-ray, which satisfies the conditions of Proposition 5.1.1.

Proof. We have $\min(H_i^X, H_i^Y) \leq \min(H_{i+1}^X, H_{i+1}^Y)$ by construction, and cofinality follows from Subsection 3.3.1 (same holds for \max). We arranged our functions so that the region of equality is of the form $D \times S^1$ for some domain D (as in Remark 5.2.3). Notice that the mixing regions, which contain all the non-constant orbits, are disjoint from D . It follows that the conditions of Proposition 5.2.2 are satisfied for H_i^X and H_i^Y , and the rest follows by the discussion in Section 5.2. \square

Therefore, we proved:

Theorem 5.4.3. *Let X and Y be two compact domains such that $\partial X \cap \partial Y$ is empty. Then, we have an exact sequence:*

$$\begin{array}{ccc}
 SH_M(X \cup Y) & \longrightarrow & SH_M(X) \oplus SH_M(Y) \\
 \uparrow [1] & \swarrow & \\
 SH_M(X \cap Y), & &
 \end{array} \tag{5.4.0.1}$$

where the degree preserving maps are the restriction maps (up to sign).

5.5 Barriers

We start with an informal discussion. Let us consider the simplest example with the boundaries of two domains intersecting to explain what goes wrong for our strategy in general. Take two small disks inside a surface intersecting in the minimal way in an eye-shaped region. Now the Hamiltonians in the acceleration data coming from boundary accelerators will have periodic orbits that make circles around the boundary for all 4 subsets in question. It is clear that in this case no continuation map equation can have topological energy 0 solutions.

Continuing the informal discussion, we now motivate the definition to come in a slightly simplified setup. Let $N = Y \times [0, 1]$ be a symplectic manifold with boundary, and $f : N \rightarrow [0, 1]$ be any Hamiltonian such that $f^{-1}(0) = Y \times \{0\}$ and $f^{-1}(1) = Y \times \{1\}$. Let $D \subset Y$ be a compact domain, and consider the subset $S := D \times [0, 1] \subset N$. The boundary of S has two portions: the horizontal one that overlaps with the boundary of N , and the vertical one coming from the boundary of D . We want to come up with a way to guarantee that if an orbit of X_f intersects S then it is contained in it. It appears as though the only feasible way to guarantee this is to assume that X_f has some directionality along the vertical boundary of S , more precisely, that X_f cannot be (strictly) inward pointing and (strictly) outward pointing at different

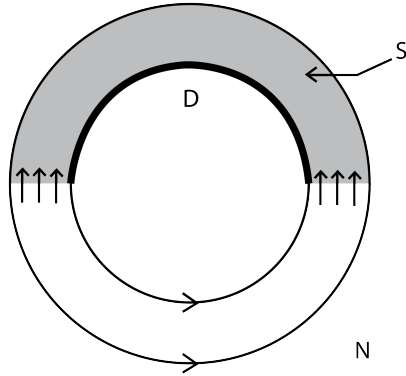

Figure 5-4: The arrows here point in the direction of the Hamiltonian vector field X_f

points along the vertical boundary of S . Let us assume that it is never strictly outward pointing. See Figure 5-4 for a depiction of the situation. Using energy conservation at the horizontal boundary, this shows that the flow of X_f moves S into itself. But, since Hamiltonian flows preserve volume, the only way for this happen is that X_f should be everywhere tangent to the vertical boundary as well.

Note that this is a very non-generic situation. Energy levels of f will generically be transverse to the vertical boundary. Elementary symplectic geometry shows that intersections of these level sets with the vertical boundary then have to be coisotropics of rank 2 (set $X =$ level set, and $Z = X \cap \partial S$ in the following lemma).

Lemma 5.5.1. *Let $X \subset M$ be a hypersurface. Take another hypersurface $Z \subset H$. Then, the characteristic line field of X is tangent to Z if and only if Z is a coisotropic (rank 2).*

Proof. If the characteristic line field is tangent to Z , then the kernel of $\omega|_Z$ is at least one dimensional. By the classification of skew-symmetric bilinear forms this means that the kernel in question is actually at least two dimensional. By the non-degeneracy of the symplectic form on M , we get that Z is a coisotropic.

Conversely, if Z is a coisotropic, then its symplectic orthogonal distribution needs to contain the characteristic line field of X . This is because a linear map from a two dimensional vector space to a one dimensional one has at least one dimensional kernel. \square

We repeat the definition of a barrier from the introduction in light of this discussion.

Definition 10. *Let Z^{2n-2} be a closed manifold. We define a **barrier** to be an embedding $Z \times [-\epsilon, \epsilon] \rightarrow M^{2n}$, for some $\epsilon > 0$, where $Z \times \{a\} \rightarrow M$ is a coisotropic for all $a \in [-\epsilon, \epsilon]$. We call the vector field obtained by pushing forward $\partial_\epsilon \in \Gamma(Z \times \{0\}, T(Z \times (-\epsilon, \epsilon))|_{Z \times \{0\}})$ to M the **direction** of the barrier.*

Remark 5.5.2. *The reader will notice that we lost some generality here. All we need from the barrier is that the Hamiltonian flow of certain functions, of which the barrier is not a level set, are tangent to it. The product decomposition into coisotropics is not necessary but has a more geometric flavor, which we find appealing. We will come back to the more general statement, which uses a more functional language, in Section 5.9 Theorem 5.9.1, and the proofs are all written so that no extra work is necessary for the generalization.*

Now, we go back to the formal discussion.

Definition 11. *We say that a Hamiltonian $f : M \rightarrow \mathbb{R}$ is **compatible** with a hypersurface Y (possibly with boundary) if the Hamiltonian vector field X_f is tangent to Y and ∂Y .*

Let B be the image of a barrier $Z \times [-\epsilon, \epsilon] \rightarrow M$.

Lemma 5.5.3. *Let $h : M \rightarrow \mathbb{R}$ be a Hamiltonian. If h is constant along $Z \times \{a\}$ for all $a \in [-\epsilon, \epsilon]$, then h is compatible with B .*

Proof. Let $z \in Z \times \{a\}$. We know that for any vector v at z tangent to $Z \times \{a\}$, the directional derivative of h along v is zero. This is equivalent to $\omega(v, X_h(z)) = 0$. By coisotropy, $X_h(z)$ is tangent to $Z \times \{a\}$, finishing the proof. \square

In the following B could be any hypersurface with boundary, but we will apply it when it is the image of a barrier, so we state it in that situation.

Lemma 5.5.4. *Take an embedding $B \times [-\delta, \delta] \rightarrow M$ extending $B = \text{im}(Z \times [-\epsilon, \epsilon]) \subset M$. Let $h : M \times [0, 1] \rightarrow \mathbb{R}$ be a function, and let ϕ_h denote its Hamiltonian flow. There exists a $\tau > 0$ such that, if for some B -compatible \tilde{h} , $|h_t - \tilde{h}|_{C^2} < \tau$ for all $t \in [0, 1]$, then no trajectory of ϕ_h starting at a point on $B \times \{\pm\delta\}$ can intersect B within time 1.*

Proof. This is a simple application of Arzela-Ascoli theorem. Assuming the contrary, we find a contradiction to the fact the Hamiltonian flow of a B -compatible function is tangent to the barrier and its boundary. \square

5.6 Non-degeneracy

This section is a long remark on why we cannot restrict ourselves to barrier compatible Hamiltonians, and can be skipped on first reading. We start with an elementary lemma.

Lemma 5.6.1. *h is compatible with a hypersurface X , if and only if it is constant along the characteristic leaves of X*

Proof. Let $X = \{f = 0\}$ for some function f with $df \neq 0$ along X . h is compatible with X iff $df(X_h) = 0$ along X . Moreover, $df(X_h) = \{f, h\} = -dh(X_f) = -X_f(h)$. The claim follows. \square

Using the embedding of the barrier, we can construct compatible Hamiltonians with the stronger property that they are constant along the rank 2 coisotropics making

up the barrier (as in Lemma 5.5.3). The definition of compatibility does not impose this a priori, but the lemma above shows that we may be forced to it nevertheless as there might be characteristic lines of B , which are dense inside $Z \times \{a\}$ for almost all a 's

The upshot for us is that we may not have a single compatible $M \times S^1 \rightarrow \mathbb{R}$ with non-degenerate periodic orbits. The problematic orbits are the ones that lie inside the barrier. In fact if $\dim(M) \geq 8$, one can show by a Jacobian computation that in the scenario described above with the dense characteristic lines we can never make those orbits non-degenerate for barrier compatible Hamiltonians. Fortunately, we can be a little more flexible as in Lemma 5.5.4.

5.7 The proof of the main theorem

Definition 12. *We say that a sequence of approximating domains D_X^i and D_Y^i **have barriers** if there are barriers $Z^i \times [-\epsilon_i, \epsilon_i] \rightarrow M$ such that*

- $\partial D_X^i \pitchfork \partial D_Y^i = Z^i \times \{0\}$
- *The direction of the barrier points strictly outside of $D_X^i \cup D_Y^i$*

Theorem 5.7.1. *Assume that X and Y admit a sequence of approximating domains with barriers. Then, we have the following exact sequence:*

$$\begin{array}{ccc} SH_M(X \cup Y) & \longrightarrow & SH_M(X) \oplus SH_M(Y), \\ \uparrow [1] & \swarrow & \\ SH_M(X \cap Y) & & \end{array} \quad (5.7.0.1)$$

where the degree preserving maps are the restriction maps (up to sign).

Our strategy is exactly the same as in the proof of Theorem 5.4.3. We will construct a cofinal sequence H_i^X and H_i^Y satisfying the conditions of Proposition

5.2.2, which will give us the theorem by Proposition 5.1.1. Of course now we have to deal with the intersection of the mixing regions using the barrier.

5.7.1 Neighborhoods of intersections of the boundary

Let K_1 and K_2 be two domains such that $\partial K_1 \cap \partial K_2 = Z$. Let $F : D \times Z \rightarrow M$ to be an embedding, where D is an open disk, and the map is identity at the zero section. We can assume that $D \times \{z\}$ is transverse to both ∂K_1 and ∂K_2 for all $z \in Z$, by restricting the domain of F .

Making **compactly supported modifications** to a domain K inside F means that we find another domain K' such that outside of a compact subset of $im(P)$, $K = K'$. We will be able to apply this operation as we wish in what is to come.

We can picture $P^{-1}(K \cap im(P))$ as the union (over $z \in Z$) of regions inside $D \times \{z\}$. Possibly restricting P to a smaller disk neighborhood we can assume that all these regions look like one side of a curve, passing through the origin, properly embedded inside the disk. By making compactly supported modifications and then restricting to a smaller neighborhood we can make all those curves linear.

Assume that our F makes the curves in the disks linear for both K_1 and K_2 . Note that these lines in the disk are all oriented. We can also make the lines perpendicular to each other for the standard metric on the disk. Note that oriented lines of K_2 are obtained by making a 90 degrees rotation to the ones of K_1 along the quadrant which does not belong to either of the subsets in question. On each connected component of Z , this rotation is either always positive or always negative. Hence the data of the portion of the sets inside F is equivalent to a map $Z \rightarrow S^1$, and a sign assigned to each connected component of Z . The sign does not play a role in the following discussion.

By making compactly supported modifications and restricting domains, we can

make this map $Z \rightarrow S^1$ any other one that is homotopic to it.¹ Moreover, if we want to, by reparametrizing F with a fibrewise rotation diffeomorphism of $D \times Z$, we can make it nullhomotopic. Let us call such an F an intersection framing.

5.7.2 Tangentialization

The last ingredient in the proof is a procedure we call tangentialization. See Figure 5-5 for a simple cartoon - we will have to be a lot more careful. We want to construct mixing regions for X and Y which can be rearranged to mixing regions for $X \cap Y$ and $X \cup Y$ (note though that in the end what matters is the cofinal functions we constructed and that they satisfy Proposition 5.2.2).

Definition 13. *Let $Z \times [-\epsilon, \epsilon] \rightarrow M$ be a barrier. We call an embedding $Z \times [-\epsilon', \epsilon'] \times [-\delta, \delta] \rightarrow M$ with $\delta > 0$ and $\epsilon' > \epsilon$ extending the barrier a **thickening** of the barrier. Let us call the image of the barrier B , and the image of the thickened barrier P . A subset A of M is called **barrier-friendly** if the preimage of $A \cap P$ in $Z \times [-\epsilon', \epsilon'] \times [-\delta, \delta]$ is of the form $Z \times S$, where S is a subset of $[-\epsilon', \epsilon'] \times [-\delta, \delta]$ for some thickening.*

Let D_X^i and D_Y^i be a sequence of approximating domains with barriers. The upshot of the discussion in the previous section is that, for their defining barrier, we can assume that D_X^i and D_Y^i are barrier friendly and the subset of the square look as in the left picture of Figure 5-6, because of the outward pointing condition.

Definition 14. *We say that the boundary accelerators $(f_i^X, N_X^i, \Delta_i^X)$ and $(f_i^Y, N_Y^i, \Delta_i^Y)$ are **compatible with barriers** if:*

- $\Delta_i^X = \Delta_i^Y$
- N_X^i and N_Y^i are barrier-friendly (for the same thickening), with the subsets of the square as described in the right picture of Figure 5-6. To elaborate, we take

¹Homotopy classes of such maps are in one to one correspondance with $H^1(Z, \mathbb{Z})$.

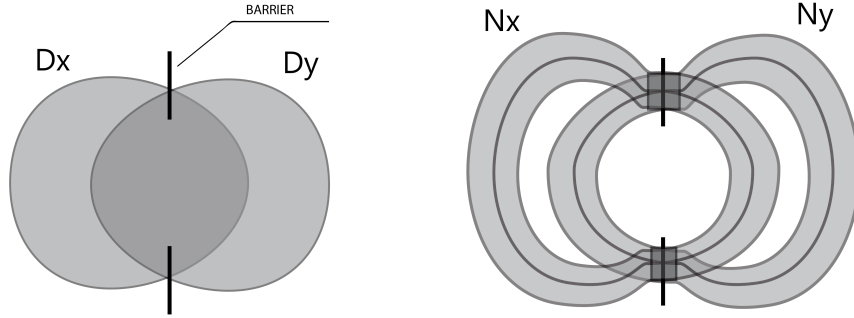

Figure 5-5: A cartoon of the tangentialization process. On the left we see a member of the approximating domains with their barrier, and on the right the mixing regions that are compatible with the barrier. Note that all the labels have an i superscript which we dropped from the picture.

a curve in $[-\epsilon', \epsilon'] \times [-\delta, \delta]$ that is the graph of a non-decreasing smooth function of δ that is equal to 0 exactly for $[-\delta/10, \delta/10]$. We take one of the subsets as the κ -neighborhood (for the standard metric) of this curve, and the other subset is obtained by reflecting along the ϵ' -axis. Let us call the barrier friendly subset obtained from the rectangle that is the product of $[-\delta/10, \delta/10]$ on the δ -axis and $[-\kappa, \kappa] \subset [-\epsilon', \epsilon']$ the **plaster**. Finally, N_X^i and N_Y^i do not intersect elsewhere.

- $f_i^X = f_i^Y$ along the plaster, and $f_i^X \neq f_i^Y$ anywhere else on $N_X^i \cap N_Y^i$.
- f_i^X is compatible with the barrier B_i .

Proposition 5.7.2. We can find h_i^X and h_i^Y as in Proposition 5.3.4 such that

- The corresponding boundary accelerators are compatible with barriers.
- $\min(h_i^X, h_i^Y) \leq \min(h_{i+1}^X, h_{i+1}^Y)$ on $\text{fill}(N_X^{(i+1)-}) \cap \text{fill}(N_Y^{(i+1)-})$.
- The region where $h_i^X = h_i^Y$ contains a subset that looks like the black region from the Figure 5-7. Let us be more precise. We push $\text{fill}(\partial N_X^{i-}) \cap \text{fill}(\partial N_Y^{i-})$

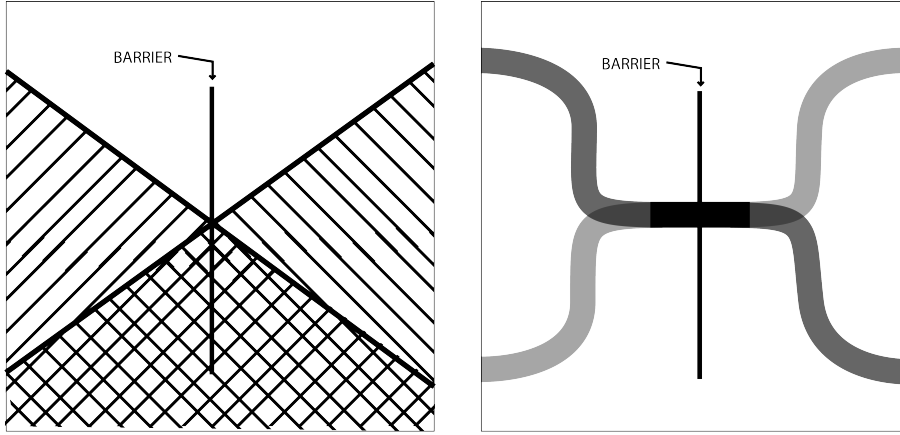

Figure 5-6: Zooming in near the barrier for barrier friendly regions at a slice. The left picture shows the barrier compatible approximating domains after making the original ones barrier friendly by compactly supported perturbations. The right one shows the barrier compatible mixing regions and the barrier.

*inwards, and $\text{fill}(\partial N_X^{i+}) \cap \text{fill}(\partial N_Y^{i+})$ outwards a little (so that they still intersect the barrier). We also take a (thinner) thickening of the barrier, which in particular intersects N_X^i and N_Y^i only along the plaster. The union of these three regions is what the black region represents. We refer to the new (thinner) thickening as the **bridge**.*

- *The connected components of the complement of the black region fall into two groups: the ones that contain $\text{fill}(\partial N_Y^{i-}) - \text{fill}(\partial N_X^{i-})$ (X -dominated), and the ones that contain $\text{fill}(\partial N_X^{i-}) - \text{fill}(\partial N_Y^{i-})$ (Y -dominated). We require that $h_i^X \geq h_i^Y$ on X dominated components, and $h_i^Y \geq h_i^X$ on the Y -dominated ones.*

Proof. We first construct the boundary accelerators that are compatible with the barriers. We do compactly supported modifications to barrier friendly neighborhoods of ∂D_X^i and ∂D_Y^i inside the thickening, and get the mixing regions of the desired shape. We construct the excitation functions so that inside the thickening they are lifts of functions on the square.

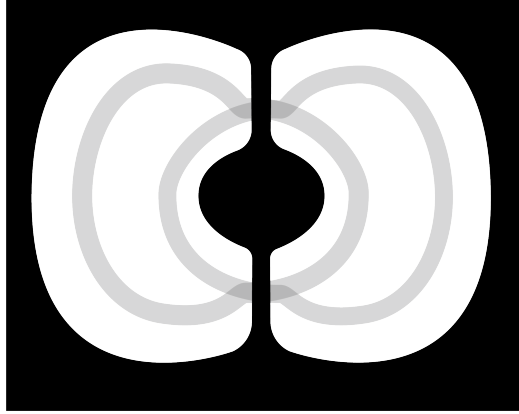

Figure 5-7: The black region is a subset of the region of equivalence for the two functions we construct. One can also see the X and Y -dominated regions. Notice how the conditions of Proposition 5.2.2 are going to hold by way of restricting the non-constant orbits to lie on the mixing regions and using almost barrier compatible functions.

We then extend the excitation functions to smooth functions on M as in the first bullet point of the proof of the Proposition 5.3.4, so that the domination property, with their regions of equivalence containing a given black region, is satisfied. Then, we use compactly supported (monotone) Morsifications outside of the mixing regions (the black region might get slightly smaller at this step) and a compatible flattening procedure to achieve what we want as before. \square

Final step is to make the Hamiltonians non-degenerate. Let us call the intersection of the original bridge with the plaster T , and let us also fix a slightly thinner one, and call the intersection T' .

Proposition 5.7.3. *Let h_i^X and h_i^Y be as above. We can find $H_i^X : M \times S^1 \rightarrow \mathbb{R}$ and $H_i^Y : M \times S^1 \rightarrow \mathbb{R}$ such that*

- *They satisfy the conditions in Proposition 5.3.5 (with $n = 3$ and some $\tau > 0$).*
- *$H_i^X = H_i^Y$ along T' , and the X and Y domination property still holds, outside of the new black region where T is replaced by T' .*

Proof. As before we only do perturbations that are compactly supported in the corresponding mixing regions. First make a perturbation inside T to both functions. Then do monotone perturbations separately in the complement of T' ensuring that the domination property continues to hold. \square

Finally, choose the τ so that the Lemma 5.5.4 applies with the thickening there being T' . This finishes the proof of Theorem 5.7.1 by Proposition 5.2.2 as before, because no periodic orbit can pass from the X -dominated region to the Y -dominated one (and vice versa).

5.8 Instances of barriers

As we have mentioned before, the outward pointing condition can be relaxed to a more cohomological condition. Namely:

Proposition 5.8.1. *Assume that we have a sequence of approximating domains D_X^i and D_Y^i , and barriers $Z^i \times [-\epsilon_i, \epsilon_i] \rightarrow M$ such that*

- $\partial D_X^i \cap \partial D_Y^i = Z^i \times \{0\}$
- *The vector field ∂_{ϵ_i} has winding number 0 with respect to the homotopy class of trivializations of the normal bundle of Z_i induced by D_X^i and D_Y^i .*

Then there exists a sequence of approximating domains with barriers for X and Y .

When $\dim(M) = 2$ the barrier condition can be satisfied only when the boundaries of the approximating domains do not intersect. For $\dim(M) = 4$, the cohomological condition becomes of importance.

Lemma 5.8.2. *Consider the standard neighborhood of a Lagrangian torus $T^2 \times \mathbb{R}_p^2, \omega = dq_1 \wedge dp_1 + dq_2 \wedge dp_2$, where we think of $T^2 = \mathbb{R}_q^2 / \sim$. If $T^2 \rightarrow T^2 \times \mathbb{R}^2$ is a Lagrangian section, which is nowhere zero, then the map $T^2 \rightarrow \mathbb{R}^2 - \{0\} \rightarrow S^1$ is nullhomotopic.*

Proof. Such Lagrangian sections correspond to closed 1-forms on T^2 . Any nowhere vanishing 1-form α on T^2 would define a map $T^2 \rightarrow \mathbb{R}^2 - \{0\} \rightarrow S^1$, and we can talk about its homotopy class h_α . Notice that h_α only depends on the cooriented foliation given by α . More precisely, we fix an orientation of T^2 and hence a coorientation of the foliation induces an orientation. We also fix a trivialization of TT^2 given by the coordinates we used in the statement of the Lemma. Then to any embedded loop $S^1 \rightarrow T^2$ we can assign a number that is the winding of the oriented line field given by the foliation w.r.t to the trivialization of the tangent bundle. This number is the same for homotopic loops, and the assignment determines the homotopy class h_α in question. In particular, if we can show that, for $d\alpha = 0$, the number of two non-homotopic embedded loops are 0, we will be done.

By an elementary result of Tischler ([21] Theorem 29, which follows from the proof of [37] Theorem 1), we can find a submersion $\theta : X \rightarrow S^1$ such that the foliation given by the fibers is arbitrarily close to the foliation defined by α . Hence, we are reduced to showing the statement for $\alpha = d\theta$. Notice that we can find an embedded loop that is transverse to all the fibres of θ . If we can show that the winding number of the fiber loops and the transverse loop are both zero, we will be done.

First note that any homotopically non-trivial embedded loop on our torus can be isotoped through embedded loops into a linear loop. This can be shown by unfolding the given loop to \mathbb{R}^2 . We draw the straight line between its endpoints, and by a small isotopy make our curve transverse to the straight line. Then we cancel intersections between the two curves by isotoping our (curvy) curve along ribbons, using the Schoenflies theorem. We finish by Schoenflies theorem again. This shows that the winding number of the tangent lines of any homotopically non-trivial embedded loop is zero. This finishes the proof. \square

Remark 5.8.3. *Note that if the section is not required to be Lagrangian, meaning that α is not necessarily closed, we can realize all homotopy classes of maps $T^2 \rightarrow S^1$*

by inserting Reeb components. Our proof above is basically showing that when α is closed there can be no Reeb components in the foliation.

Corollary 5.8.4. *Let D and D' be two domains with transversely intersecting boundaries along a disjoint union of Lagrangian tori L . Then, L can be extended to an outward pointing barrier if and only if the intersection (as in Subsection 5.7.1) and Lagrangian (see [11] for the simple definition) framings of L agree.*

5.9 Involutive systems

Recall the following definition from the introduction.

Definition 15. *We say that compact subsets K_1, K_2, \dots, K_n of M satisfy **descent**, if $SC_M(K_1, \dots, K_n)$ is acyclic.*

Satisfying descent implies the existence of a convergent spectral sequence:

$$\bigoplus_{0 \neq I \subset [n]} SH_M \left(\bigcap_{i \in I} K_i \right) \Rightarrow SH_M \left(\bigcup_{i=1}^n K_i \right), \quad (5.9.0.1)$$

which produces a Mayer-Vietoris sequence for $n = 2$.

5.9.1 A slight generalization of the main theorem

Theorem 5.9.1. *Let $f_i^X : M \rightarrow \mathbb{R}$ and $f_i^Y : M \rightarrow \mathbb{R}$ be smooth functions such that*

1. $(f_i^X)^{-1}((-\infty, 0])$ and $(f_i^Y)^{-1}((-\infty, 0])$ approximate X and Y respectively
2. Let $f := (f_i^X, f_i^Y) : M \rightarrow \mathbb{R}^2$. There exists a smooth curve C passing through the origin once and intersecting only the first and third quadrants such that

$$\{f_i^X, f_i^Y\} |_{f^{-1}(C)} = 0. \quad (5.9.1.1)$$

Note that this condition is automatically satisfied if $f^{-1}(C) = \emptyset$.

Then X and Y satisfy descent.

The proof of this version is absolutely the same. $f^{-1}(C)$ plays the role of a barrier. It is a little more general in that it admits a map $f^{-1}(C) \rightarrow \mathbb{R}$ with coisotropic fibres, but the fibres are possibly singular. We draw the pictures that we were drawing in the $\epsilon\delta$ plane before, for the manipulations near the barrier, in the target plane of the map f near the origin (Figure 5-8). In this framework, we can see the entirety of M and the subsets in our pictures, which is nice. We make the subsets tangential by making the subsets inside \mathbb{R}^2 tangential near the origin, tangent direction being transverse to C . We construct the excitation functions as functions of f_i^X and f_i^Y . Such functions are all compatible with $f^{-1}(C)$, because of the following lemma (we are using $k = 2$ only here).

Lemma 5.9.2. *Let $f_1, \dots, f_k : M \rightarrow \mathbb{R}$, and $g_1, g_2 : \mathbb{R}^k \rightarrow \mathbb{R}$ be smooth functions. Assume that $\{f_i, f_j\} = 0$ at $x \in M$, for all i, j . Then the functions $G_i : M \rightarrow \mathbb{R}$, $i = 1, 2$, defined by $x \mapsto g_i(f_1(x), \dots, f_k(x))$ also satisfy $\{G_1, G_2\} = 0$ at $x \in M$.*

Proof. We have that $\{h, h'\} = \omega(X_h, X_{h'})$. Moreover, dG_i is a C^∞ linear combination of df_1, \dots, df_k , and hence X_{G_i} is the same linear combination of X_{f_1}, \dots, X_{f_k} . This finishes the proof. \square

We are able to satisfy the regularity conditions that are required from the excitation functions at the boundary of mixing regions by Sard's lemma. The construction proceeds as before.

5.9.2 Descent for symplectic manifolds with involutive structure

Definition 16. *An **involutive map** is a smooth map $\pi : M \rightarrow B$ to a smooth manifold B , such that for any $f, g \in C^\infty(B)$, we have $\{f \circ \pi, g \circ \pi\} = 0$*

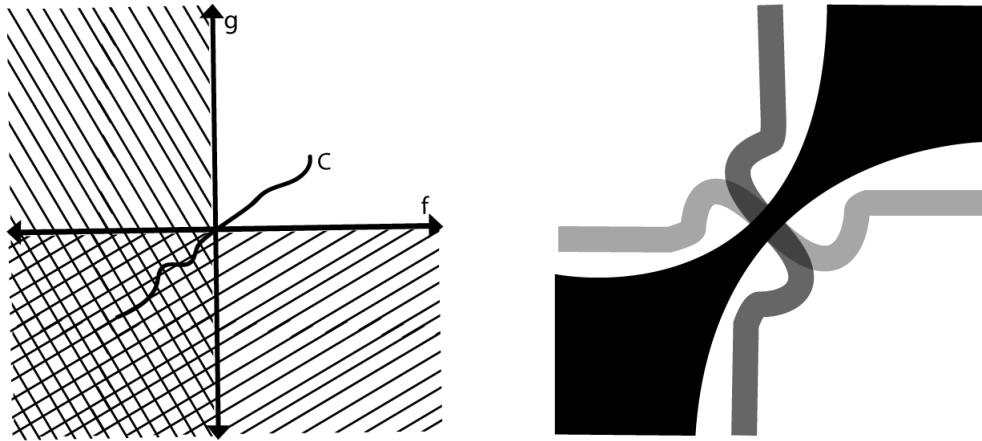

Figure 5-8:

Theorem 5.9.3. *Let X_1, \dots, X_n be closed subsets of B . Then $\pi^{-1}(X_1), \dots, \pi^{-1}(X_n)$ satisfy descent.*

Proof. It in fact suffices to show this for $n = 2$ (see Appendix B for the easy inductive argument). In that case, we have already proved a stronger version in Theorem 5.9.1, as we can use functions on B to get the sequences of functions in Theorem 5.9.1. \square

Remark 5.9.4. *For multiple subsets, there is a more optimal theorem we could have proved. First of all, note that for $n > 2$, domains being pairwise equipped with barriers (generalized or not) is not enough to conclude that the n subsets satisfy descent. Let us stick to $n = 3$ for simplicity. Having a barrier between D_1 and D_2 , and D_1 and D_3 does not imply a priori that there is a barrier between D_1 and $D_2 \cup D_3$. Apart from the non-matching problem at the triple intersection at the boundary, there can also be no guaranteed way of gluing the barriers together. This is because of the outward pointing condition near the triple intersection that is essential. In this case, it would be enough to assume that the three functions in question all pairwise commute in a neighborhood of the triple intersection of the boundaries of the domains. Currently, such generalizations seem to be useless.*

Appendix A

Cubical diagrams

We show that n -cube families of Hamiltonians give n -cubes using Pardon's results on simplex families. The main challenge here is to show that the signs work out correctly.

Let $Cube = [0, 1]^n$, with an ordering of its coordinates. We can cover it by $n!$ simplices, one for each permutation (i_1, \dots, i_n) of $(1, \dots, n)$. We can think of such a permutation as a path that starts at $(0, \dots, 0)$ and takes a unit step in the positive i_k direction at time $k = 1, \dots, n$, and ends up at $(1, \dots, 1)$. The corresponding simplex $\Delta^n \rightarrow Cube$ is the linear map that sends the i th vertex of the simplex to the i th vertex we encounter on this path.

Now let H be a $Cube$ family of Hamiltonians. Let F be a k -dimensional face of the $Cube$. F itself is a cube with an induced ordering of its coordinates. By the above procedure it can be covered by $k!$ simplices. We get a map $C_{\nu_{in}} \rightarrow C_{\nu_{ter}}$ for each of these simplices by restricting the family of Hamiltonians. We define

$$f_F = \sum_{k! \text{ simplices}} (-1)^{sign} f_{(j_1, \dots, j_k)}, \quad (\text{A.0.0.1})$$

where (j_1, \dots, j_k) is the permutation corresponding to the simplex, and sign is given by its signature. We claim that these define a cubical diagram. We need to show that

the Equation (2.2.1.1) from Subsection 2.2.1:

$$\sum_{F' > F'' \text{ is a bdry of } F} (-1)^{*_{F',F}} f_{F'} f_{F''} = 0, \quad (\text{A.0.0.2})$$

is satisfied for each face F . Recall that $*_{F',F} = \#_v 1 + \#_v 0 1$ for $v = \nu_{ter} F' - \nu_{in} F'$ considered as a vector inside F . Without loss of generality, we will show the one for the top dimensional face.

By Pardon (Equation (7.6.5)), we get $n!$ equations of the form below for the top dimensional face of each of the simplices in the cover.

$$\sum_k (-1)^{k+1} g_{(1,\dots,k)} g_{(k,\dots,n)} + \sum_k (-1)^k g_{(1,\dots,\hat{k},\dots,n)} = 0 \quad (\text{A.0.0.3})$$

We add all of these equations up after multiplying them with $(-1)^{sign}$, where sign is again the signature of the permutation corresponding to the simplex. The second group of terms cancel out because the signature of a permutation changes after one transposition. Using the description of the signature of a permutation via the number of inversions, we see that we get exactly the equation we wanted from the first group of terms.

Appendix B

Descent for multiple subsets

Let K_1, \dots, K_n be compact subsets of M . Let \mathcal{K} be smallest set of subsets of M , which is closed under intersection and union, and contains K_1, \dots, K_n .

Assume that for any $X, Y \in \mathcal{K}$, $SH_M(X, Y) = 0$. Then, we want to show that for any $X_1, \dots, X_l \in \mathcal{K}$, $SH_M(X_1, \dots, X_l) = 0$. We do this by induction. Assume that it holds for $l - 1 \geq 2$.

By the descent for two subsets we have that the natural map

$$\begin{array}{ccc} SC_M(X_1 \cup \dots \cup X_l) & & (B.0.0.1) \\ \downarrow & & \\ \text{cone}(SC_M(X_1) \oplus SC_M(X_2 \cup \dots \cup X_l)) & \rightarrow & SC_M((X_2 \cap X_1) \cup \dots \cup (X_l \cap X_1)) \end{array}$$

is a quasi-isomorphism.

We also have homotopy commutative diagrams:

$$\begin{array}{ccc} SC_M(X_2 \cup \dots \cup X_l) & \longrightarrow & SC_M((X_2 \cap X_1) \cup \dots \cup (X_l \cap X_1)) & (B.0.0.2) \\ \downarrow & & \downarrow & \\ \bigoplus_{0 \neq I \subset \{2, \dots, l\}} SC_M(\bigcap_{i \in I} X_i) & \longrightarrow & \bigoplus_{0 \neq I \subset \{2, \dots, l\}} SC_M(\bigcap_{i \in I} (X_i \cap X_1)), \end{array}$$

and

$$\begin{array}{ccc}
 SC_M(X_1) & \longrightarrow & SC_M((X_2 \cap X_1) \cup \dots \cup (X_l \cap X_1)) \\
 & \searrow & \downarrow \\
 & & \bigoplus_{0 \neq I \subset \{2, \dots, l\}} SC_M \left(\bigcap_{i \in I} (X_i \cap X_1) \right),
 \end{array} \tag{B.0.0.3}$$

In these two diagrams, by the direct sum we mean the homotopy colimit of the corresponding homotopy coherent diagram. By the induction hypothesis all the vertical arrows are quasi-isomorphisms.

By piecing together these diagrams, we see that the cone in (B.0.0.1) is quasi-isomorphic to $\bigoplus_{0 \neq I \subset \{1, \dots, l\}} SC_M \left(\bigcap_{i \in I} X_i \right)$ in a way that is compatible with the maps that they receive from $SC_M(X_1 \cup \dots \cup X_l)$. This finishes the proof.

Bibliography

- [1] Mohammed Abouzaid. Family Floer cohomology and mirror symmetry. *arXiv preprint, arXiv:1404.2659*.
- [2] Mohammed Abouzaid, Denis Auroux, Alexander Efimov, Ludmil Katzarkov, and Dmitri Orlov. Homological mirror symmetry for punctured spheres. *Journal of the American Mathematical Society*, 26(4):1051–1083, 2013.
- [3] Mohammed Abouzaid and Paul Seidel. An open string analogue of Viterbo functoriality. *Geometry & Topology*, 14(2):627–718, 2010.
- [4] Peter Albers and Urs Frauenfelder. Rabinowitz Floer homology: a survey. *Global differential geometry, Springer Proc. Math.*, 17:437–461, 2012.
- [5] Frédéric Bourgeois and Alexandru Oancea. Symplectic homology, autonomous Hamiltonians, and Morse-Bott moduli spaces. *Duke Mathematical Journal*, 146(1):71–174, 2009.
- [6] K. Cieliebak, A. Floer, and H. Hofer. Symplectic homology. II. A general construction. *Mathematische Zeitschrift*, 218(1):103–122, 1995.
- [7] K. Cieliebak and A. Oancea. Symplectic homology and the eilenberg-steenrod axioms. *ArXiv e-prints: 1511.00485*, November 2015.
- [8] Daniel Dugger. A primer on homotopy colimits. preprint <http://pages.uoregon.edu/ddugger/hocolim.pdf>.
- [9] Y. Eliashberg and N. Mishachev. *Introduction to the h-principle*, volume 48 of *Graduate Studies in Mathematics*. American Mathematical Society, Providence, RI, 2002.
- [10] Michael Entov and Leonid Polterovich. Quasi-states and symplectic intersections. *Commentarii Mathematici Helvetici. A Journal of the Swiss Mathematical Society*, 81(1):75–99, 2006.

- [11] Ronald Fintushel and Ronald J. Stern. Invariants for Lagrangian tori. *Geometry and Topology*, 8:947–968, 2004.
- [12] A. Floer and H. Hofer. Symplectic homology. I. Open sets in \mathbf{C}^n . *Mathematische Zeitschrift*, 215(1):37–88, 1994.
- [13] Kenji Fukaya. Multivalued Morse theory, asymptotic analysis and mirror symmetry, graphs and patterns in mathematics and theoretical physics, 205–278. In *Proc. Sympos. Pure Math*, volume 73.
- [14] Yoel Groman. Floer theory and reduced cohomology on open manifolds. *ArXiv e-prints 1510.04265*, October 2015.
- [15] Mark Gross and Bernd Siebert. From real affine geometry to complex geometry. *Annals of Mathematics*, pages 1301–1428, 2011.
- [16] Jungsoo Kang. Symplectic homology of displaceable Liouville domains and leaf-wise intersection points. *Geometriae Dedicata*, 170:135–142, 2014.
- [17] Irving Kaplansky. Modules over Dedekind rings and valuation rings. *Transactions of the American Mathematical Society*, 72:327–340, 1952.
- [18] Maxim Kontsevich and Yan Soibelman. Homological mirror symmetry and torus fibrations,. *Symplectic geometry and mirror symmetry (Seoul, 2000)*, 203–263, *World Sci*.
- [19] Maxim Kontsevich and Yan Soibelman. Affine structures and non-archimedean analytic spaces. *Progress in Mathematics*, 244:321, 2006.
- [20] P. B. Kronheimer and T. S. Mrowka. Khovanov homology is an unknot-detector. *Publications Mathématiques. Institut de Hautes Études Scientifiques*, (113):97–208, 2011.
- [21] H. Blaine Lawson, Jr. Foliations. *Bulletin of the American Mathematical Society*, 80:369–418, 1974.
- [22] Heather Lee. Homological mirror symmetry for open riemann surfaces from pair-of-pants decompositions. *arXiv preprint arXiv:1608.04473*, 2016.
- [23] John M. Lee. *Introduction to smooth manifolds*, volume 218 of *Graduate Texts in Mathematics*. Springer, New York, second edition, 2013.
- [24] Naichung Conan Leung. Mirror symmetry without corrections. *Communications in Analysis and Geometry*, 13(2):287, 2005.

- [25] Mark Mclean. Birational Calabi-Yau manifolds have the same small quantum product. *preprint*.
- [26] Grigory Mikhalkin. Decomposition into pairs-of-pants for complex algebraic hypersurfaces. *Topology. An International Journal of Mathematics*, 43(5):1035–1065, 2004.
- [27] Alexandru Oancea. A survey of Floer homology for manifolds with contact type boundary or symplectic homology. *Symplectic geometry and Floer homology, Soc. Brasil. Mat., Rio de Janeiro*, 7:51–91, 2004.
- [28] John Pardon. Contact homology and virtual fundamental cycles. *ArXiv e-prints 1508.03873*, August 2015.
- [29] John Pardon. An algebraic approach to virtual fundamental cycles on moduli spaces of pseudo-holomorphic curves. *Geometry & Topology*, 20(2):779–1034, 2016.
- [30] Dietmar Salamon. Lectures on Floer homology. *Symplectic geometry and topology (Park City, UT, 1997)*, 7:143–229, 1999.
- [31] Matthias Schwarz. On the action spectrum for closed symplectically aspherical manifolds. *Pacific Journal of Mathematics*, 193(2):419–461, 2000.
- [32] Paul Seidel. *Fukaya categories and Picard-Lefschetz theory*. Zurich Lectures in Advanced Mathematics. European Mathematical Society (EMS), Zurich, 2008.
- [33] Paul Seidel. Some speculations on pairs-of-pants decompositions and Fukaya categories. *Surveys in differential geometry. Vol. XVII*, 17:411–425, 2012.
- [34] The Stacks Project Authors. *Stacks Project*. <http://stacks.math.columbia.edu>, 2018.
- [35] Elias M. Stein. *Singular integrals and differentiability properties of functions*. Princeton Mathematical Series, No. 30. Princeton University Press, Princeton, N.J., 1970.
- [36] Andrew Strominger, Shing-Tung Yau, and Eric Zaslow. Mirror symmetry is T-duality. *Nuclear Physics B*, 479(1-2):243–259, 1996.
- [37] D. Tischler. On fibering certain foliated manifolds over S^1 . *Topology. An International Journal of Mathematics*, 9:153–154, 1970.
- [38] Sara Venkatesh. Rabinowitz Floer homology and mirror symmetry. *ArXiv e-prints 1705.00032*, April 2017.

- [39] C. Viterbo. Functors and computations in Floer homology with applications. I. *Geometric and Functional Analysis*, 9(5):985–1033, 1999.
- [40] Charles A. Weibel. *An introduction to homological algebra*, volume 38 of *Cambridge Studies in Advanced Mathematics*. Cambridge University Press, Cambridge, 1994.
- [41] James A. Yorke. Periods of periodic solutions and the Lipschitz constant. *Proceedings of the American Mathematical Society*, 22:509–512, 1969.